

Singer 7-9

Singer 7-34

Singer 7-48

Form 19130

(338)

Printed in U. S. A.

LIST OF PARTS



MACHINES
Nos. 7-9, 7-34 and 7-48

THE SINGER MANUFACTURING COMPANY

INSTRUCTIONS FOR OILING

Oil should be applied frequently to all holes marked "OIL", also the shuttle race, the hole in the hub of the friction driving pulley, and other places where there are parts in movable contact.

Turn up the round cover plate at the back of the machine and lubricate all the moving parts inside. Then turn the cover plate back into position and tighten the screw.

Copyright, U. S. A., 1916, 1918, 1927 and 1938
by The Singer Manufacturing Co.
All Rights Reserved for all Countries

INDEX

	Page
Accessories.....	15
Binder (Adjustable) No. 120233.....	15
Binder (Adjustable) No. 120304.....	16
Binders on Shank.....	16
Bobbin Winders.....	17
Corder (Adjustable).....	22
Driving Attachment.....	22
Hemmers on Shank.....	24
Lap Seam Feller.....	24
Machine No. 7-9.....	5
Machine No. 7-34.....	13
Machine No. 7-48.....	14
Numerical List of Parts.....	29
Obsolete Parts.....	25
Piping Attachment.....	24
Table Belt Guide.....	24
Thread Unwinder.....	25

INSTRUCTIONS FOR ORDERING

In ordering from this list, use ONLY the part NUMBER in the FIRST column.

The number stamped on a Sewing Machine Part is in every case the number of the single part only.

Every combination of parts sent out as such has its specific number, which, although not stamped on the parts, must be used when ordering the combination.

Each number always indicates the SAME PART in whatever list it appears, or for whatever machine.

The letters after some of the numbers indicate the style of finish only, as follows:

- A-Hardened, Polished, Nickel Plated and Buffed
- B-Polished, Nickel Plated and Buffed
- C-Hardened Only
- D-Polished Only
- E-Soft, Not Polished
- F-Hardened and Polished
- F.J-Hardened, Polished and Nickel Plated
- G-Bright Rumbled and Nickel Plated
- H-Blued
- J-Nickel Plated Only
- K-Hardened and Nickel Plated
- L-Brass Plated
- M-Oxidized
- N-Japanned, Dull
- P-Japanned, Bright
- R-Merlized
- S-Cadmium Plating
- T-Copper Plated
- T.A-Hardened, Polished, Copper and Nickel Plated and Buffed
- T.B-Copper and Nickel Plated and Polished
- T.J-Copper and Nickel Plated Only
- T.K-Hardened, Copper and Nickel Plated
- T.L-Copper and Brass Plated
- T.M-Copper Plated and Oxidized
- U-Zinc Plated
- V-Silver Plated
- W-Polished and Nickel Plated
- X-Black Oxide, for Iron and Steel
- X.C-Hardened and Black Oxide, for Iron or Steel
- Y-Black Nickel Plated Only
- Z-Chromium Plated
- Z.A-Hardened, Polished, Nickel Plated, Buffed and Chromium Plated
- Z.B-Polished, Nickel Plated, Buffed and Chromium Plated
- Z.C-Hardened and Chromium Plated
- Z.J-Nickel and Chromium Plated

These letters MUST BE USED when they appear in the list; and AFTER the number as in the list.

In this series:

- 1 to 1500, 50001 to 51500 and 140001 to 142000 are Screw Numbers
- 1501 to 1800 and 51501 to 51800 are Nut Numbers
- 1801 to 2000 and 51801 to 52000 are Roller Numbers
- 2001 to 50000 and 52001 to 140000 and 142001 to 190000 are Sewing Machine Parts, 190001 and upward are numbers of Electrical Parts.

The figures in the second column refer only to the plates, illustrating the parts, and are NOT TO BE USED in ordering.

Parts marked with an asterisk (*) are furnished only when repairs are made at factory.

LIST OF PARTS COMPLETE

FOR

MACHINE No. 7-9

For Awnings (Including Binding) Mail Bags, Rugs, Robes, Canvas Covers, Horse Collars, Traces, Hassocks, Life Preservers, Sails, Stair Pads, Tents, Toe Pads, etc. Stitch 3/32 inch to 9/16 inch long. Has drop feed, alternating pressers and S. D. A. Speed 650, according to the material being stitched.

No.	Plate	Name
*19502	-----	Arm with 15404 and two 15405.....
8702	9632	" Dowel Pin.....
50348E	9632	" Screw.....
58329	7847	" Shaft.....
11354	9633	" " Bushing.....
437C	9632	" " " Set Screw.....
949D	9632	" " Screw.....
9842	9632	" " " Washer.....
11913	9633	" Side Cover.....
65D	9632	" " " Hinge Screw.....
8708	9633	" Spool Pin.....
11241	9632	" " " Washer (cloth).....
122301	9634	Balance Wheel with two 354C.....
122302	-----	" " " 122301 with 11442, 122469, two 1402E and four 401E.....
25362	9632	Balance Wheel Ball, size 3/16 in.....
*122303	-----	" " " Ring.....
122304	7851	" " " " 122303 with eighteen 25362.....
122306	7851	Balance Wheel Ball Washer (left).....
122469	9632	" " " " (right).....
1402E	9632	" " " " " Screw.....
11442	9634	" " Friction Washer (paper)...
401E	9632	" " " " " Screw.....
354C	9632	" " " Set Screw.....
*11359	-----	Bed.....
11363	9634	Crank Connecting Rod with two 145E.....
145E	9632	" " " Cap Screw.....

PARTS FOR MACHINE No. 7-9

No.	Plate	Name
565C	9632	Crank Connecting Rod Hinge Screw.....
1513J	9632	" " " " " Nut....
11365	7851	Feed Bar.....
307C	9632	" " Screw Center.....
*56814	-----	" " " " 307C with 1513J...
1513J	9632	" " " " Nut.....
11367	9633	" Cam with two 445C.....
445C	9632	" " Set Screw.....
11368	4465	" Connecting Link.....
565C	9632	" " " " Hinge Screw.....
1513J	9632	" " " " Nut....
11369	9635	" Dog, 14 teeth (10 teeth to the inch).....
166D	9635	Feed Dog Screw.....
11370	9634	" Forked Connection.....
*58231	-----	" " " 11370 with 11368, 11375, 50322D and two each 565C and 1513J.....
565C	9632	Feed Forked Connection Hinge Screw.....
1513J	9632	" " " " " Nut..
19970	7847	" Lifting Rock Shaft with 134D, 2022, and 19967.....
19812	9633	Feed Lifting Rock Shaft Crank with 346E and 1861.....
346E	4465	Feed Lifting Rock Shaft Crank Clamping Screw.....
1861	9636	Feed Lifting Rock Shaft Crank Roller and Stud.....
564C	9636	Feed Lifting Rock Shaft Screw Center....
58384	-----	" " " " " 564C with 1508E.....
1508E	9636	Feed Lifting Rock Shaft Screw Center Nut
19967	4465	" " " " Wearing Block...
2022	4465	" " " " " Po- sition Pin.....
134D	4465	Feed Lifting Rock Shaft Wearing Block Screw.....
19971	-----	Feed Lifting Rock Shaft complete, Nos. 19812 and 19970.....
11375	9633	Feed Regulator.....
568E	9636	" " Hinge Screw.....
50322D	9636	" " Thumb Screw.....
58233	7847	" Rock Shaft.....
58235	4465	" " " Crank with 346E.....
346E	4465	" " " Clamping Screw....
564C	9636	" " " Screw Center.....
58384	-----	" " " " 564C with 1508E.....
1508E	9636	Feed Rock Shaft Screw Center Nut.....

PARTS FOR MACHINE No. 7-9

No.	Plate	Name
58234	-----	Feed Rock Shaft complete, Nos. 58233 and 58235.....
25881	7847	Guide (6 in. face).....
254D	9636	" Thumb Screw.....
11475	9633	Lifting Presser Bar.....
58617	9633	" " " Bell Crank.....
58618	9638	" " " " Hinge Stud
50083C	9638	" " " " " " " Set Screw.....
58619	9638	Lifting Presser Bar Bell Crank Slide Block.....
58621	-----	Lifting Presser Bar Bell Crank Slide Block 58619 with 610D.....
610D	4465	Lifting Presser Bar Bell Crank Slide Block Screw.....
1518E	4465	Lifting Presser Bar Bell Crank Slide Block Screw Nut.....
2718	4465	Lifting Presser Bar Bell Crank Slide Block Screw Nut Washer.....
58643	9633	Lifting Presser Bar Bracket with two 145E.....
145E	9632	Lifting Presser Bar Bracket Clamping Screw.....
11909	9633	Lifting Presser Bar Lifter with 8761 and 8763.....
8760	4465	Lifting Presser Bar Lifter Friction Washer.....
16D	9636	Lifting Presser Bar Lifter Hinge Screw..
8761	4465	" " " " Stop Pin....
11907	7851	" " " Lifting Link.....
166D	9635	" " " " Cap Screw
8763	4465	" " " " " Hinge Stud.....
8973	4465	Lifting Presser Bar Lifting Link Hinge Stud Pin.....
43267	4465	Lifting Presser Bar Lifting Link Hinge Stud Washer.....
11479	9637	Lifting Presser Bar Rock Shaft.....
58578	9637	" " " " " Adjusting Arm with 453C.....
2117	9636	Lifting Presser Bar Rock Shaft Adjusting Arm Pin.....
453C	9636	Lifting Presser Bar Rock Shaft Adjusting Arm Set Screw.....
11481	9637	Lifting Presser Bar Rock Shaft Bracket..
*58245	-----	" " " " " 11481 with 2117, 11479, 11484 and 58578...
2002	9636	Lifting Presser Bar Rock Shaft Bracket Dowel Pin (lower).....

No.	Plate	Name
4389	9636	Lifting Presser Bar Rock Shaft Bracket Dowel Pin (upper).....
123E	9636	Lifting Presser Bar Rock Shaft Bracket Screw.....
11484	9637	Lifting Presser Bar Rock Shaft Crank with 453C and 1850.....
2117	9636	Lifting Presser Bar Rock Shaft Crank Pin
1850	9636	" " " " " Roller and Stud.....
453C	9636	Lifting Presser Bar Rock Shaft Crank Set Screw.....
11486	9637	Lifting Presser Bar Rock Shaft Eccentric Strap with two each 141E and 1528C..
141E	9636	Lifting Presser Bar Rock Shaft Eccentric Strap Adjusting Screw.....
1528C	9636	Lifting Presser Bar Rock Shaft Eccentric Strap Adjusting Screw Nut.....
608C	9636	Lifting Presser Bar Rock Shaft Eccentric Strap Hinge Screw.....
1518E	4465	Lifting Presser Bar Rock Shaft Eccentric Strap Hinge Screw Nut.....
11487	9636	Lifting Presser Bar Rock Shaft Eccentric Strap Hinge Screw Slide.....
11488	9636	Lifting Presser Bar Rock Shaft Eccentric Strap Hinge Screw Slide Washer.....
258E	9636	Lifting Presser Bar Screw Bushing.....
11489	9637	" " " Sleeve (lower).....
11490	9637	" " " " (upper).....
11491	-----	" " " " " 11490 with 11492.....
11492	9638	Lifting Presser Bar Sleeve (upper) Cap..
11493	9634	" " " Spring (flat).....
58252	7851	" " " " Bracket.....
1177D	9638	" " " " " Screw
4389	9636	" " " " Guide Pin....
50323D	9638	" " " " Regulating Thumb Screw.....
11496	9635	Lifting Presser Foot with 211F.....
11927	9635	" " " " 211F.....
2049	9635	" " " Pin.....
211F	9635	" " " Set Screw.....
11380	7851	Needle Bar.....
*11539	9637	" " Connecting Link.....
566C	9638	" " " " Hinge Screw..
1513J	9632	" " " " " Nut
11383	9638	" " " Stud with two 445F
19981	-----	" " " " 11383 with 11539.....
445F	9632	Needle Bar Connecting Stud Set Screw....

No.	Plate	Name
258E	9636	Needle Bar Screw Bushing.....
19702	9638	" Clamp with 680F and 11385.....
*11385	9638	" " Q1b.....
680F	9638	" " Thumb Screw.....
58253	-----	Oil Cup.....
11917	7847	" " Cover.....
9084	9638	" " " Hinge Pin.....
2205	9638	" " " Latch Spring.....
207F	9638	" " " " " Screw.....
8953	9638	" or Wax Stripper (felt).....
11918	9638	" " " " Washer (steel).....
8482	9638	" " " " " (steel).....
207F	9638	" " " " " Screw.....
58254	7847	Oil Cup complete, Nos. 2205, 8482, 9084, 11917, 11918, 58253, two 8953 and three 207F.....
134D	4465	Oil Cup Screw.....
58573	9637	Oscillating Rock Shaft.....
58585	9637	" " " Hinge Pin.....
58586	-----	" " " " " 58586 with 1508J.....
1508J	9636	Oscillating Rock Shaft Hinge Pin Nut....
51237C	9638	" " " " " Screw Bearing.....
1508J	9636	Oscillating Rock Shaft Hinge Pin Screw Bearing Nut.....
11165	9638	Oscillating Rock Shaft Oil Pad.....
58567	9639	" " " " Tube with 58569.....
58568	9639	Oscillating Rock Shaft Oil Tube Joint...
127848	9639	" " " " " Oil Cup.
*58569	-----	" " " " " Sleeve..
58570	9639	Oscillating Rock Shaft Oil Tube complete, Nos. 58567, 58568 and 127848.....
58566	-----	Oscillating Rock Shaft complete, Nos. 1508J, 11165, 51237C, 58570, 58573 and 58586.....
11850	9634	Oscillating Shaft.....
11393	9638	" " Collar with two 453C..
453C	9636	" " " Set Screw.....
11848	-----	" " Crank.....
40025	9639	" " " Pin.....
453C	9636	" " " Set Screw.....
19696	9639	Oscillating Shaft Crank complete, Nos. 453C, 1513J, 5868 and 11848.....
9119	9639	Oscillating Shaft Crank Slide Block....
190J	9639	" " " " Cap Screw.....
5968	9639	Oscillating Shaft Crank Slide Block Cap Screw Washer.....

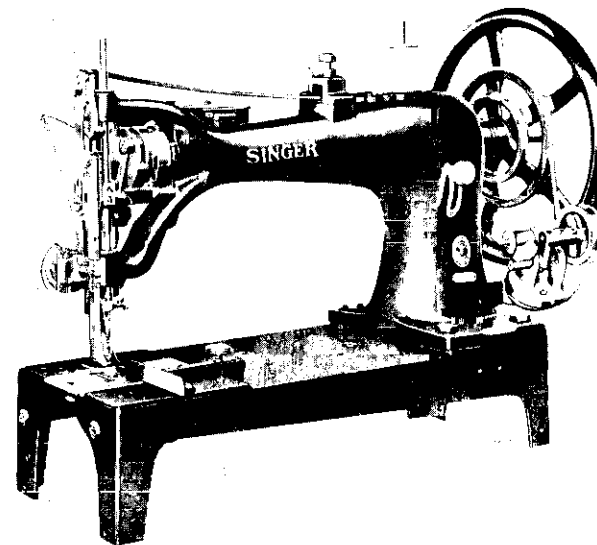
No.	Plate	Name
1054C	9639	Oscillating Shaft Crank Slide Block Screw Stud.....
1513J	9632	Oscillating Shaft Crank Slide Block Screw Stud Nut.....
5868	9639	Oscillating Shaft Crank Slide Block com- plete, Nos. 190J, 1054C, 5968 and 9119
11910	9640	Shuttle Bobbin.....
19977	9640	" Cylinder.....
58213	-----	" " 19977 with 773F and 19979
58527	9640	" " Hinge Pin.....
58626	9640	" " Latch.....
12002	9640	" " " Pin.....
122419	9640	" " " Spring.....
58525	9640	Shuttle (cylinder) 3 in. diam. complete, Nos. 11910, 58213, 58524 and 58527..
11856	9637	Shuttle Driver with 453C.....
2117	9636	" " Pin.....
453C	9636	" " Set Screw.....
58523	9640	" Frame.....
58524	-----	" " 58523 with 12002, 58626 and 122419.....
11832	9637	Shuttle Race Back.....
11833	9639	" " " Position Pin.....
19577	7851	" " " Spring.....
32D	9639	" " " Screw.....
11835	-----	" " Body.....
11837	9634	" " Frame with 11838.....
670E	9639	" " " Clamping Screw.....
11838	9639	" " " Position Pin.....
11418	9642	" " Slide (left).....
11500	9642	" " " (right).....
180D	9639	" " " Screw.....
11836	9634	Shuttle Race complete, Nos. 32D, 11832, 11835, 19577 and two 11833.....
134D	4465	Shuttle Race Screw.....
773F	9639	" Tension Regulating Screw.....
19979	9639	" " Spring.....
11502	9642	Tension Bracket and Vibrating Presser Bar Cap with 11424.....
11501	-----	Tension Bracket and Vibrating Presser Bar Cap complete, Nos. 122E, 9525, 11502, 11506, 11936, 11937, 12042 and two 190J.....
159F	9639	Tension Bracket and Vibrating Presser Bar Cap Screw (left).....
145F	9632	Tension Bracket and Vibrating Presser Bar Cap Screw (right).....
5983	9639	Tension Friction Washer (felt).....
11423	9639	" " " (steel).....

No.	Plate	Name
1560C	9639	Tension Regulating Thumb Nut.....
8905	9641	" " " " Washer.....
607E	9641	" Screw Stud.....
58598	-----	" " " 607E with 1560C.....
122E	9641	" " " Clamping Screw.....
8791	4474	" Spring.....
11044	4474	" Wheel.....
12042	-----	Tension (wheel) complete, Nos. 8791, 8905, 11044, 11423, 58598 and two 5983....
11424	4474	Thread Eyelet for 11502.....
11950	4474	" " " 11503.....
11495	9641	" " (side of arm).....
190J	9639	" " " " " Screw.....
2102	4474	" Retaining Disc.....
1560C	9639	" " Regulating Thumb Nut...
8905	9641	" " " " " "
		Washer.....
606E	4474	Thread Retaining Screw Stud.....
58597	-----	" " " " 606E with 1560C.....
2103	4474	Thread Retaining Spring.....
11503	-----	Thread Retainer complete, Nos. 2103, 8905, 58597 and two, 2102.....
11505	9642	Thread Take-up Cam with two 434C.....
8873	9641	" " " Pin.....
434C	9641	" " " Set Screw.....
58295	-----	" " Lever.....
58296	7851	" " " 58295 with 1995....
58320	-----	" " " 58296 with 50437D..
50437D	9641	" " " Hinge Screw.....
1995	9641	" " " Roller and Screw Stud with 1518E.....
1518E	4465	Thread Take-up Lever Roller and Screw Stud Nut.....
11506	4474	Thread Take-up Spring.....
11936	4474	" " " Regulator Plate...
190J	9639	" " " " " Ad- justing Screw.....
11937	4474	Thread Take-up Spring Staple.....
9525	4474	" " " " Washer.....
11432	-----	Throat Plate Body.....
11434	9635	" " Needle Plate, round needle hole for 11433.....
11435	9635	Throat Plate Needle Plate, oblong needle hole for 58241.....
219F	9635	Throat Plate Needle Plate Screw.....
11433	9635	Throat Plate complete, Nos. 219F, 11432 and 11434.....
58241	-----	Throat Plate complete, Nos. 219F, 11432 and 11435.....

No.	Plate	Name
381D	9635	Throat Plate Screw.....
*15404	-----	Trade Mark.....
15405	-----	" " Rivet.....
11508	9642	Vibrating Presser Bar.....
11509	9641	" " " Cushion (rawhide).
233D	9641	" " " " Screw.....
58620	9642	" " " Hinge Bracket with 145E.....
145E	9632	Vibrating Presser Bar Hinge Bracket Ad- justing Screw.....
164D	9641	Vibrating Presser Bar Hinge Cap Screw...
41544	9641	" " " " " "
		Washer.....
11512	9642	Vibrating Presser Bar Spring.....
11939	9641	" " " " Adjusting Staple.....
190J	9639	Vibrating Presser Bar Spring Adjusting Staple Screw.....
223D	9641	Vibrating Presser Bar Spring Screw.....
11513	9635	" " " Foot.....
898D	9635	" " " Screw.....
1547D	9635	" " " Nut.....

Genuine Singer Needles should be used in Singer Machines. These Needles and their Containers are marked with the Company's Trade Mark "SIMANCO." 1

Needles in Containers marked "For Singer Machines" are not Singer made needles. 2



MACHINE No. 7-34

For Awnings, Mail Bags, Rugs, Robes, Canvas Covers, Horse Collars, Traces, Hassocks, Life Preservers, Sails, Stair Pads, Tents, Toe Pads, etc. Stitch 3/32 inch to 9/16 inch long. Has drop feed and alternating pressers. Speed 650, according to the material being stitched.

NOTE: THIS MACHINE IS THE SAME AS THE 7-9 MACHINE WITH THE FOLLOWING EXCEPTIONS:

No.	Plate	Name
11353	9643	Arm Shaft in place of 58329.....
11358	9646	Balance Wheel (two speed) with two 354C for Stand, in place of 122302.....
58411	9646	Balance Wheel with two 354C for Under Driver, in place of 122302.....

From the library of: Diamond Needle Corp

MACHINE No. 7-48

For Awnings (Including Binding) Mail Bags, Rugs, Robes, Canvas Covers, Horse Collars, Traces, Hassocks, Life Preservers, Sails, Stair Pads, Tents, Toe Pads, etc. Stitch 3/32 inch to 9/16 inch long. Has drop feed, alternating pressers and belt shifter. Speed 650, according to the material being stitched.

NOTE: THIS MACHINE IS THE SAME AS THE 7-9 MACHINE WITH THE FOLLOWING EXCEPTIONS:

No.	Plate	Name
11878	9643	Arm Shaft, in place of 58329.....
58407	9643	Balance Wheel and Pulley (tight) with two 354C, in place of 122302.....
6439	-----	Belt Shifter Chain, 36 in. to 45 in., with 56864 and 56865.....
4879	9644	Belt Shifter Chain Connecting Link.....
11446	9644	" " " Eyelet.....
56864	9644	" " " Hook (large).....
56865	9644	" " " " (small).....
11447	9644	" " " Pulley.....
567D	9644	" " " " Screw.....
11940	9643	" " " Fork.....
434C	9641	" " " Set Screw.....
11941	9643	" " " Frame with 8804 and two 434C.....
8804	-----	Belt Shifter Frame Handle.....
11450	9645	" " " Guide Rod.....
2117	9636	" " " " Pin.....
58408	9647	" " " Pulley (loose).....
58409	9645	" " " " Flanged Bushing with two 435C.....
435C	9644	Belt Shifter Pulley (loose) Flanged Bushing Set Screw.....
11451	9645	Belt Shifter Slide Rod.....
11453	9644	" " " " Collar with two 448C.....
448C	9644	Belt Shifter Slide Rod Collar Set Screw.....
2117	9636	" " " " Pin.....
11942	9645	" " " " Spring.....
11453	9644	" " " " Collar with two 448C.....

No.	Plate	Name
448C	9644	Belt Shifter Slide Rod Spring Collar Set Screw.....
4881	9647	Belt Shifter Treadle.....
4882	9644	" " " Shaft.....
4883	9644	" " " Spring.....
4884	9647	" " " Stand.....
4885	9647	Belt Shifter Treadle complete, Nos. 4879, 4881 to 4884 and two wood screws 1 in. No. 16.....
11945	-----	Belt Shifter complete, Nos. 567D, 4885, 6439, 11446, 11447, 11450, 11451, 11940 to 11942, 58408, 58409 and two each 2117 and 11453.....
58659	9645	Vibrating Presser Bar Hinge Bracket with 145E, in place of 58620.....

ACCESSORIES

No.	Plate	Name
11361	9645	Bed Bracket (left) with wood screw 1 in. No. 16.....
11360	9645	Bed Bracket (right) with wood screw 1 in. No. 16.....
507E	9644	Bed Bracket Bolt with 1515E.....
1515E	9644	" " " Nut.....
120344	9649	Oiler (copper plated) with 120345.....
120345	9649	" Spout, 4 1/2 in. long.....
11831	9649	Screw Driver (large).....
26026	9649	" " (small).....
120571	9640	Shuttle (cylinder) Opener.....
8908	9649	Wrench for 1520.....
8909	9649	" " 1513.....
8910	9649	" " 1508.....
23535	9649	" " 346, 1528 and 1547.....

BINDER (Adjustable)

TO TURN IN BOTH EDGES OF IMITATION LEATHER

BINDING FOR HEAVY MATERIAL

FOR 7-34 MACHINE

No.	Plate	Name
120229	9648	Binder Bed with two each 1036C and 1266C
120230	9648	" Edge Guide.....

BINDER (Adjustable)

No.	Plate	Name
671D	9648	Binder Edge Guide Thumb Screw.....
120231	9648	" Guide (lower).....
120232	9648	" " (upper).....
51224W	9648	" " Thumb Screw.....
1036C	9648	" Leveling Screw (back).....
1266C	9648	" " " (front).....
120233	9648	Binder (adjustable) complete, Nos. 671D, 51224W and 120229 to 120232.....

BINDER (Adjustable)

TO TURN IN BOTH EDGES OF IMITATION LEATHER
BINDING FOR HEAVY MATERIAL
FOR 7-9 AND 7-34 MACHINES

No.	Plate	Name
120229	9648	Binder Bed with two each 1036C and 1266C
120230	9648	" Edge Guide.....
671D	9648	" " " Thumb Screw.....
120302	7853	" Guide (lower).....
120303	7853	" " (upper).....
51224W	9648	" " Thumb Screw.....
1036C	9648	" Leveling Screw (back).....
1266C	9648	" " " (front).....
120304	-----	Binder (adjustable) complete, Nos. 671D, 51224W, 120229, 120230, 120302 and 120303.....

BINDERS ON SHANK

No.	Plate	Name
26790	9650	Binder on Shank, for harness housings...
26791	9650	" " " " binding leather....
26792	9650	" " " " harness work.....
11369	9635	Feed Dog, 14 teeth, (10 teeth to the inch) for 11433, 26790 to 26792 and 58241.....
19712	22786	Lifting Presser Foot with 211F for cloth, for 26790 and 26792.....
19713	22786	Lifting Presser Foot with 211F for leather, for 26790 and 26792.....

BINDERS ON SHANK

17

No.	Plate	Name
11927	9635	Lifting Presser Foot with 211F for 26791
211F	9635	" " " Set Screw.....
11432	-----	Throat Plate Body.....
11434	9635	" " Needle Plate, round needle hole.....
11435	9635	Throat Plate Needle Plate, oblong needle hole.....
219F	9635	Throat Plate Needle Plate Screw.....
11433	9635	Throat Plate complete for 11369 and 26790 to 26792, Nos. 219F, 11432 and 11434.....
58241	-----	Throat Plate complete for 11369 and 26790 to 26792, Nos. 219F, 11432 and 11435.....
19716	22786	Vibrating Presser Foot for 26790 and 26792.....
11513	9635	Vibrating Presser Foot for 26791.....

BOBBIN WINDERS

BOBBIN WINDER

(SWINGING AUTOMATIC, RIGHT HAND)
FOR FLAT OR ROUND BELT, FOR 11910

No.	Plate	Name
41439	22788	Base with 458C, 27916 and two 28084.....
41398	22789	Bobbin Carrier Key.....
27916	22789	Brake (leather).....
28084	22789	" Rivet.....
41440	22788	Frame.....
41441	22789	" Hinge Pin.....
458C	22789	" " " Set Screw.....
4784	22789	" Oil Pad (felt).....
41442	22789	" Spring.....
41443	22788	Pulley with 155C.....
155C	22789	" Set Screw.....
41444	22788	Spindle with 41398.....
41557	6781	Stop Latch.....
*60630	-----	" " 41557 with 2269 and 41446...
41446	6781	" " Hinge Pin.....
2269	22789	" " Pin.....

BOBBIN WINDER

No.	Plate	Name
41447	22789	Tripping Arm with 176E.....
176E	22789	" " Clamping Screw.....
41558	22788	Bobbin Winder, Nos. 41439 to 41444,41447, 60630, two 4784 and three wood screws 1 in. No. 7.....

THREAD UNWINDER PARTS

FOR ONE LARGE SPOOL

No.	Plate	Name
27555	3582	Spool Pin.....
41450	3582	" Rest.....
41451	-----	" " 41450 with 138B and 27555....
138B	22789	" " Set Screw.....
27557	3582	" Stand with 138B.....
41514	3582	" Weight, 4 in. diam., with 41515...
41515	22789	" " Center Pin.....
2102	4474	Tension Disc.....
1560C	9639	" Regulating Thumb Nut.....
828C	4474	" Screw Stud.....
42418	-----	" " " 828C with 1560C.....
2103	4474	" Spring.....
5769	4474	" Thread Eyelet.....
17547	4474	" " Guard.....
60608	3582	Thread Guard.....
27560	3582	" " Rod, 26 in. long.....
138B	22789	" " " Set Screw.....
330E	22789	" " Set Screw.....
60609	-----	Thread Guard complete, Nos. 330E, 2103, 5769,17547,42418,60608 and two 2102.
41454	3582	Thread Unwinder complete, for one large spool Nos. 27557,27560,41451,41514, 60609 and three wood screws 1 1/4 in. No. 12.....
41559	-----	Bobbin Winder (swinging automatic, right hand) complete, Nos. 41454 and 41558

BOBBIN WINDER

(SWINGING AUTOMATIC, RIGHT HAND)

FOR FLAT OR ROUND BELT, FOR 11910

No.	Plate	Name
41439	22788	Base with 458C, 27916 and two 28084.....
41398	22789	Bobbin Carrier Key.....
27916	22789	Brake (leather).....

BOBBIN WINDER

No.	Plate	Name
28084	22789	Brake Rivet.....
41440	22788	Frame.....
41441	22789	" Hinge Pin.....
458C	22789	" " " Set Screw.....
4784	22789	" Oil Pad (felt).....
41442	22789	" Spring.....
41443	22788	Pulley with 155C.....
155C	22789	" Set Screw.....
41444	22788	Spindle with 41398.....
41557	6781	Stop Latch.....
*60630	-----	" " 41557 with 2269 and 41446....
41446	6781	" " Hinge Pin.....
2269	22789	" " Pin.....
41447	22789	Tripping Arm with 176E.....
176E	22789	" " Clamping Screw.....
41558	22788	Bobbin Winder, Nos.41439 to 41444,41447, 60630,two 4784 and three wood screws 1 in. No. 7.....

THREAD UNWINDER PARTS

FOR TWO LARGE SPOOLS

No.	Plate	Name
27555	3582	Spool Pin.....
27583	7285	" Rest.....
27556	-----	" " 27583 with 138B and two 27555
138B	22789	" " Set Screw.....
27557	3582	" Stand with 138B.....
2102	4474	Tension Disc.....
1560C	9639	" Regulating Thumb Nut.....
828C	4474	" Screw Stud.....
42418	-----	" " " 828C with 1560C.....
2103	4474	" Spring.....
5769	4474	" Thread Eyelet.....
17547	4474	" " Guard.....
60608	3582	Thread Guard.....
27560	3582	" " Rod, 26 in. long.....
138B	22789	" " " Set Screw.....
330E	22789	" " Set Screw.....
60609	-----	Thread Guard complete, Nos. 330E, 2103, 5769,17547,42418,60608 and two 2102.
41823	7285	Thread Unwinder complete, for two large spools, Nos. 27556,27557,27560,60609 and three wood screws 1 1/4 in.No.12
41824	-----	Bobbin Winder (swinging automatic, right hand) complete, Nos. 41558 and 41823

BOBBIN WINDER
(SWINGING AUTOMATIC, LEFT HAND)

FOR 11910

FOR 122302, FOR 7-9 MACHINE

No.	Plate	Name
41894	6781	Base with 449C.....
894D	22789	" Screw.....
41895	22789	Bobbin Carrier Key.....
41896	7851	Frame.....
41441	22789	" Hinge Pin.....
449C	22789	" " " Set Screw.....
4784	22789	" Oil Pad (felt).....
41897	7851	" Spring.....
43270	22788	Friction Pulley with 43271, two 448C and ten 26070.....
43271	22788	Friction Pulley Ring (leather).....
26070	22789	" " " Rivet.....
448C	9644	" " " Set Screw.....
41898	6781	Spindle with 41895.....
41557	6781	Stop Latch.....
*60630	-----	" " 41557 with 2269 and 41446....
41446	6781	" " Hinge Pin.....
2269	22789	" " Pin.....
41899	22789	Tripping Arm with 176E.....
176E	22789	" " Clamping Screw.....
41900	6781	Bobbin Winder, Nos. 41441,41894,41896 to 41899, 43270, 60630 and two 4784....
60271	9647	Bracket.....
50124D	22789	" Screw.....
9842	9632	" " Washer.....

THREAD UNWINDER PARTS
FOR TWO LARGE SPOOLS

No.	Plate	Name
27555	3582	Spool Pin.....
27583	7285	" Rest.....
27556	-----	" " 27583 with 138B and two 27555
138B	22789	" " Set Screw.....

No.	Plate	Name
27557	3582	Spool Stand with 138B.....
2102	4474	Tension Disc.....
1560C	9639	" Regulating Thumb Nut.....
828C	4474	" Screw Stud.....
42418	-----	" " " 828C with 1560C.....
2103	4474	" Spring.....
5769	4474	" Thread Eyelet.....
17547	4474	" " Guard.....
60608	3582	Thread Guard.....
27560	3582	" " Rod, 26 in. long.....
138B	22789	" " " Set Screw.....
330E	22789	" " " Set Screw.....
60609	-----	Thread Guard complete, Nos. 330E, 2103, 5769,17547,42418,60608 and two 2102.
41823	7285	Thread Unwinder complete, for two large spools, Nos. 27556,27557,27560,60609 and three wood screws 1 1/4 in.No.12
60272	-----	Bobbin Winder (swinging automatic, left hand) complete, Nos.9842,41823,41900, 50124D, 60271 and three 894D.....

BOBBIN WINDER

(SWINGING AUTOMATIC, LEFT HAND)

FOR 11910

FOR 58407, FOR 7-48 MACHINE

FOR 58411, FOR 7-34 MACHINE

THIS BOBBIN WINDER IS THE SAME AS 60272,

WITH THE FOLLOWING EXCEPTIONS:

No.	Plate	Name
60274	9647	Bracket, in place of 60271.....
60275	-----	Bobbin Winder (swinging automatic, left hand) complete, Nos.9842,41823,41900, 50124D, 60274 and three 894D.....

BOBBIN WINDER

(SWINGING AUTOMATIC, LEFT HAND)

FOR 11910

FOR 11358, FOR 7-34 MACHINE

No.	Plate	Name
60227	9647	Bracket, in place of 60271.....
60277	-----	Bobbin Winder (swinging automatic, left hand) complete, Nos.9842,41823,41900, 50124D, 60227 and three 894D.....

CORDER (Adjustable)

FOR BUGGY CUSHIONS

No.	Plate	Name
26795	22787	Cord Guide.....
26796	22787	" " Arm with 26798 and three 6037
1044D	22787	" " Hinge Screw.....
26797	22787	" " Bed.....
26798	22787	" " Bracket.....
6037	22787	" " Rivet.....
190J	9639	" " Screw.....
26799	22787	Corder complete, Nos. 190J, 1044D and 26795 to 26797.....
19715	22786	Lifting Presser Foot with 211F for 26799
211F	9635	" " Set Screw.....
14592	9650	Vibrating Presser Bar for 26799.....
26509	22786	" " Foot for 14592.....
19717	22786	" " " " 26799.....

Note: Presser Feet are used with, but not included
in No. 26799.....

DRIVING ATTACHMENT

FOR 7-9 MACHINE

No.	Plate	Name
122301	9634	Balance Wheel with two 354C.....
122302	-----	" " 122301 with 11442, 122469, two 1402E and four 401E.....
25362	9632	Balance Wheel Ball, size 3/16 in.....
*122303	-----	" " Ring.....
122304	7851	" " " " 122303 with eighteen 25362.....
122306	7851	Balance Wheel Ball Washer (left).....
122469	9632	" " " " (right).....
1402E	9632	" " " " Screw.....
11442	9634	" " Friction Washer (paper)...
401E	9632	" " " " Screw.....
354C	9632	" " Set Screw.....
8984	22794	Brake Block (wood).....
58458	22790	" " Stud.....
1036C	9648	" " Set Screw.....
11440	9647	Friction Pulley, 7 in. diam., 1 1/2 in. face with 448C and 11441.....
11441	7851	Friction Pulley Center Bearing.....

DRIVING ATTACHMENT

23

No.	Plate	Name
448C	9644	Friction Pulley Set Screw.....
58463	22791	Lever with 1036C and 58458.....
58464	-----	" 58463 with 134D, 8984, 8991, 8992, 58462 and two 497E.....
58462	9647	Lever Bracket.....
497E	22790	" " Bolt with 1522E.....
1522E	22790	" " " Nut.....
134D	4465	" Screw.....
8991	7851	" " Washer.....
8992	7851	" Spring.....
14785	22790	" " Hook (for machine on top of table).....
19863	22790	Lever Spring Hook (for machine flush with table).....
1520E	22790	Lever Spring Hook Nut.....
6055	22790	" " " " Washer.....
9091	22792	Shaft Driving Pulley (sectional) 10 in. diam., 1 1/2 in. face, 1 3/16 in. bore, with two 597C.....
597C	22790	Shaft Driving Pulley Clamping Screw....
126036	22792	Treadle.....
126037	-----	" 126036 with 2718R, 50581R and 126038
126205	-----	" Bracket (left).....
126207	22790	" " " Hook.....
23258	22790	" " " Friction Washer
126208	22790	" " " Rivet.....
126206	-----	Treadle Bracket (left) complete, Nos. 23258, 126205, 126207, 126208 and two wood screws 1 in. No. 14.....
46681	-----	Treadle Bracket (right).....
60502	-----	" " 46681 with two wood screws 1 in. No. 14.....
126038	9647	Treadle Extension.....
50581R	22790	" " Screw.....
2718R	4465	" " Washer.....
60858	22790	" Hanging Hook.....
27639	9647	" Pitman Rod.....
80223	9647	" " Clamp with 361C.....
361C	22790	" " " Screw.....
60626	9647	Treadle Pitman complete, Nos. 80223 and two 27639.....
126211	-----	Treadle complete, Nos. 60502, 126037 and 126206.....
126212	-----	Treadle and Pitman complete, Nos. 60626, 60858, and 126211.....
58508	-----	Driving Attachment complete, Nos. 1520E, 6055, 9091, 11440, 14785, 58464, 122302, 122304, 122306 and 126212.....

HEMMERS ON SHANK

No.	Plate	Name
26900	7853	Hemmer on Shank, for canvas.....
120192	7853	" " " " heavy canvas, for 7-9 Machine.....

LAP SEAM FELLER

No.	Plate	Name
26794	9650	Lap Seam Feller (left hand) on Shank, to fold top only.....
164D	9641	Lap Seam Feller Screw.....
41544	9641	" " " " Washer.....

PIPING ATTACHMENT

No.	Plate	Name
26800	9650	Piping Attachment on Shank.....
19714	22786	Lifting Presser Foot with 211F for 26800
211F	9635	" " " " Set Screw.....
19717	22786	Vibrating Presser Foot for 26800.....

TABLE BELT GUIDE

No.	Plate	Name
58263	22793	Bracket with 448C.....
58264	22793	Pulley.....
58265	22793	" Shaft with 58266 and 58267.....
58266	22794	" " Oil Hole Plug.....
58267	-----	" " Packing (wick).....
448C	9644	" " Set Screw.....
58268	-----	Table Belt Guide complete, for flat belt, for power table, Nos.58264,58265,two 58263 and eight wood screws 1 1/2 in. No. 14 R.H.....

THREAD UNWINDER

FOR TWO LARGE SPOOLS OF THREAD
FOR 5201, FOR 25207

No.	Plate	Name
60636	22792	Holder with 138B.....
27555	3582	Spool Pin.....
27583	7285	" Rest.....
27556	-----	" " 27583 with 138B and two 27555
138B	22789	" " Set Screw.....
2102	4474	Tension Disc.....
1560C	9639	" Regulating Thumb Nut.....
828C	4474	" Screw Stud.....
42418	-----	" " " 828C with 1560C.....
2103	4474	" Spring.....
5769	4474	" Thread Eyelet.....
17547	4474	" " Guard.....
60608	3582	Thread Guard.....
27693	22791	" " Rod, 37 in. long.....
138B	22789	" " Set Screw.....
330E	22789	" " Set Screw.....
60609	-----	Thread Guard complete, Nos. 330E, 2103, 5769,17547,42418,60608 and two 2102.
60637	-----	Thread Unwinder complete Nos.27556,27693, 60609, 60636 and two wood screws 1 1/4 in. No. 12.....

OBSOLETE PARTS

No.	Plate	Name
122307	7851	Balance Wheel Ball Washer (right) obso- lete, superseded by 122469, not in- terchangeable.....
286D	22794	Binder Guide Thumb Screw, use 51224W....
15405	-----	Bobbin Winder Friction Pulley Ring Rivet, use 26070.....
9D	22794	Driving Attachment Brake Block Screw,ob- solete superseded by 58458, not in- terchangeable.....
19662	22791	Driving Attachment Lever, use 58463.....

OBSOLETE PARTS

No.	Plate	Name
58378	-----	Driving Attachment Lever 19662 with 9D, 134D, 8984, 8991, 8992, 19663 and two 497E, obsolete, superseded by 58464, not interchangeable.....
19663	22792	Driving Attachment Lever Bracket, use 58462.....
27637	7847	Driving Attachment Treadle Pitman Rod (lower), for 27640.....
150208	22794	Driving Attachment Treadle Pitman Rod (lower) Spring, for 27640.....
9079	7847	Driving Attachment Treadle Pitman Rod Clamp with 354C, obsolete, superseded by 80223, not interchangeable.....
354C	9632	Driving Attachment Treadle Pitman Rod Clamp Screw, obsolete, superseded by 361C, not interchangeable.....
27640	7847	Driving Attachment Treadle Pitman complete, Nos. 2762, 6055, 27637, 27639, 80223 and 150208, obsolete, superseded by 60626, not interchangeable.....
2762	22794	Driving Attachment Treadle Stop Collar with 362C, for 27640.....
362C	22794	Driving Attachment Treadle Stop Collar Set Screw, for 2762.....
126209	-----	Driving Attachment Treadle complete, Nos. 60502, 126036 and 126206, obsolete superseded by 126211, not interchangeable.....
126210	-----	Driving Attachment Treadle and Pitman complete, Nos. 27640 and 126209, obsolete, superseded by 126212, not interchangeable.....
58379	-----	Driving Attachment complete, Nos. 1520E, 6055, 9091, 11440, 14785, 58378, 122302, 122304, 122306, and 126210, obsolete, superseded by 58508 not interchangeable.....
11476	22793	Lifting Presser Bar Bell Crank, obsolete, superseded by 58617 not interchangeable.....
11478	22793	Lifting Presser Bar Bracket with two 145E, use 58643.....
11480	22793	Lifting Presser Bar Rock Shaft Adjusting Arm with 453C, use 58578.....
11841	22793	Oscillating Rock Shaft (steel), obsolete, superseded by 58573, not interchangeable.....
11398	22794	Oscillating Rock Shaft Hinge Pin, obsolete, superseded by 58585, not interchangeable.....

OBSOLETE PARTS

No.	Plate	Name
*58293	-----	Oscillating Rock Shaft Hinge Pin 11398 with 1508J, obsolete, superseded by 58586, not interchangeable.....
622C	22794	Oscillating Rock Shaft Hinge Pin Screw Bearing, obsolete, superseded by 51237C, not interchangeable.....
11842	-----	Oscillating Rock Shaft complete, Nos. 622C, 1508J, 11165, 11841 and 58293, obsolete, superseded by 58566, not interchangeable.....
8961	22794	Shuttle Cylinder Hinge Pin, use 58527...
11853	22794	" " Latch, obsolete, superseded by 58626, not interchangeable.....
19869	22794	Shuttle Cylinder Latch Spring, obsolete, superseded by 122419, not interchangeable.....
19980	22794	Shuttle (cylinder) 3 in. diam. complete, Nos. 11910, 58212, 58213 and 59527, obsolete, superseded by 58525, not interchangeable.....
19978	22794	Shuttle Frame, obsolete, superseded by 58523, not interchangeable.....
58212	-----	Shuttle Frame 19978 with 11853, 12002 and 19869, obsolete, superseded by 58524, not interchangeable.....
11510	22793	Vibrating Presser Bar Hinge Bracket with 145E, for 7-9 and 7-34 Machines, obsolete, superseded by 58620, not interchangeable.....

NUMERICAL LIST OF PARTS

No.	Plate	Name
9D	22794	Driving Attachment Brake Block Screw, for 58378, obsolete, superseded by 58458 not interchangeable.....
16D	9636	Lifting Presser Bar Lifter Hinge Screw..
32D	9639	Shuttle Race Back Spring Screw, for 11836
65D	9632	Arm Side Cover Hinge Screw.....
122E	9641	Tension Screw Stud Clamping Screw, for 11501.....
123E	9636	Lifting Presser Bar Rock Shaft Bracket Screw.....
134D	4465	Driving Attachment Lever Screw, for 58378 and 58464.....
134D	4465	Feed Lifting Rock Shaft Wearing Block Screw, for 19970.....
134D	4465	Oil Cup Screw.....
134D	4465	Shuttle Race Screw.....
138B	22789	Thread Unwinder Spool Rest Set Screw, for 27556 and 41451.....
138B	22789	Thread Unwinder Thread Guard Rod Set Screw, for 27557 and 60636.....
141E	9636	Lifting Presser Bar Rock Shaft Eccentric Strap Adjusting Screw, for 11486....
145E	9632	Crank Connecting Rod Cap Screw, for 11363
145E	9632	Lifting Presser Bar Bracket Clamping Screw, for 11478 and 58643.....
145F	9632	Tension Bracket and Vibrating Presser Bar Cap Screw (right).....
145E	9632	Vibrating Presser Bar Hinge Bracket Adjusting Screw, for 11510, 58620 and 58659.....
155C	22789	Bobbin Winder Pulley Set Screw, for 41443
159F	9639	Tension Bracket and Vibrating Presser Bar Cap Screw (left).....
164D	9641	Lap Seam Feller Screw, for 26794.....
164D	9641	Vibrating Presser Bar Hinge Cap Screw...
166D	9635	Feed Dog Screw.....
166D	9635	Lifting Presser Bar Lifting Link Cap Screw.....
176E	22789	Bobbin Winder Tripping Arm Clamping Screw, for 41447 and 41899.....
180D	9639	Shuttle Race Slide (right) Screw.....
190J	9639	Corder Cord Guide Screw, for 26799.....
190J	9639	Oscillating Shaft Crank Slide Block Cap Screw, for 5868.....
190J	9639	Thread Eyelet (side of arm) Screw.....
190J	9639	Thread Take-up Spring Regulator Plate Adjusting Screw, for 11501.....
190J	9639	Vibrating Presser Bar Spring Adjusting Staple Screw.....

Genuine Singer Needles should be used in Singer Machines. These Needles and their Containers are marked with the Company's Trade Mark "SIMANCO." 1

Needles in Containers marked "For Singer Machines" are not Singer made needles. 2

NUMERICAL LIST OF PARTS

No.	Plate	Name
207F	9638	011 Cup Cover Latch Spring Screw, for 58254.....
207F	9638	011 or Wax Stripper Washer Screw, for 58254.....
211F	9635	Lifting Presser Foot Set Screw, for 11496, 11927 and 19712 to 19715.....
219F	9635	Throat Plate Needle Plate Screw, for 11433 and 58241.....
223D	9641	Vibrating Presser Bar Spring Screw.....
233D	9641	" " " Cushion Screw.....
254D	9636	Guide Thumb Screw.....
256E	9636	Lifting Presser Bar Screw Bushing.....
258E	9636	Needle Bar Screw Bushing.....
286D	22794	Binder Guide Thumb Screw, obsolete, use 51224W.....
307C	9632	Feed Bar Screw Center, for 56814.....
330E	22789	Thread Unwinder Thread Guard Set Screw, for 60609.....
346E	4465	Feed Lifting Rock Shaft Crank Clamping Screw, for 19812.....
346E	4465	Feed Rock Shaft Crank Clamping Screw, for 58235.....
354C	9632	Balance Wheel Set Screw, for 11358, 58407, 58411 and 122301.....
354C	9632	Driving Attachment Balance Wheel Set Screw, for 122301.....
354C	9632	Driving Attachment Treadle Pitman Rod Clamp Screw, for 9079, obsolete, superseded by 361C not interchangeable...
361C	22790	Driving Attachment Treadle Pitman Rod Clamp Screw, for 80223.....
362C	22794	Driving Attachment Treadle Stop Collar Set Screw, for 2762, obsolete.....
381D	9635	Throat Plate Screw.....
401E	9632	Balance Wheel Friction Washer Screw, for 122302.....
401E	9632	Driving Attachment Balance Wheel Friction Washer Screw, for 122302.....
434C	9641	Belt Shifter Fork Set Screw, for 11941..
434C	9641	Thread Take-up Cam Set Screw, for 11505.
435C	9644	Belt Shifter Pulley (loose) Flanged Bushing Set Screw, for 58409.....
437C	9632	Arm Shaft Bushing Set Screw.....
445C	9632	Feed Cam Set Screw, for 11367.....
445F	9632	Needle Bar Connecting Stud Set Screw, for 11383.....
448C	9644	Belt Shifter Slide Rod Collar Set Screw, for 11453.....
448C	9644	Belt Shifter Slide Rod Spring Collar Set Screw, for 11453.....

NUMERICAL LIST OF PARTS

No.	Plate	Name
448C	9644	Bobbin Winder Friction Pulley Set Screw, for 43270.....
448C	9644	Driving Attachment Friction Pulley Set Screw, for 11440.....
448C	9644	Table Belt Guide Pulley Shaft Set Screw, for 58263.....
449C	22789	Bobbin Winder Frame Hinge Pin Set Screw, for 41894.....
453C	9636	Lifting Presser Bar Rock Shaft Adjusting Arm Set Screw, for 11480 and 58578..
453C	9636	Lifting Presser Bar Rock Shaft Crank Set Screw, for 11484.....
453C	9636	Oscillating Shaft Collar Set Screw, for 11393.....
453C	9636	Oscillating Shaft Crank Set Screw, for 19696.....
453C	9636	Shuttle Driver Set Screw, for 11856.....
458C	22789	Bobbin Winder Frame Hinge Pin Set Screw, for 41439.....
497E	22790	Driving Attachment Lever Bracket Bolt with 1522E, for 58378 and 58464.....
507E	9644	Bed Bracket Bolt with 1515E (Accessories)
564C	9636	Feed Lifting Rock Shaft Screw Center, for 58384.....
564C	9636	Feed Rock Shaft Screw Center, for 58384..
565C	9632	Crank Connecting Rod Hinge Screw.....
565C	9632	Feed Connecting Link Hinge Screw.....
565C	9632	Feed Forked Connection Hinge Screw, for 58231.....
566C	9638	Needle Bar Connecting Link Hinge Screw..
567D	9644	Belt Shifter Chain Pulley Screw, for 11945.....
568E	9636	Feed Regulator Hinge Screw.....
597C	22790	Driving Attachment Shaft Driving Pulley Clamping Screw, for 9091.....
606E	4474	Thread Retaining Screw Stud, for 58597..
607E	9641	Tension Screw Stud, for 58598.....
608C	9636	Lifting Presser Bar Rock Shaft Eccentric Strap Hinge Screw.....
610D	4465	Lifting Presser Bar Bell Crank Slide Block Screw, for 58621.....
622C	22794	Oscillating Rock Shaft Hinge Pin Screw Bearing, for 11842, obsolete, superseded by 51237C not interchangeable.
670E	9639	Shuttle Race Frame Clamping Screw.....
671D	9648	Binder Edge Guide Thumb Screw, for 120233 and 120304.....
680F	9638	Needle Clamp Thumb Screw, for 19702.....
773F	9639	Shuttle Tension Regulating Screw, for 58213.....

NUMERICAL LIST OF PARTS

No.	Plate	Name
828C	4474	Thread Unwinder Tension Screw Stud, for 42418.
894D	22789	Bobbin Winder Base Screw, for 60272, 60275 and 60277.
898D	9635	Vibrating Presser Foot Screw.
949D	9632	Arm Shaft Screw.
1036C	9648	Binder Leveling Screw (back) for 120229
1036C	9648	Driving Attachment Brake Block Stud Set Screw, for 58463.
1044D	22787	Corder Cord Guide Arm Hinge Screw, for 26799.
1054C	9639	Oscillating Shaft Crank Slide Block Screw Stud, for 5868.
1177D	9638	Lifting Presser Bar Spring Bracket Screw
1266C	9648	Binder Leveling Screw (front) for 120229
1402E	9632	Balance Wheel Ball Washer (right) Screw, for 122302.
1402E	9632	Driving Attachment Balance Wheel Ball Washer (right) Screw, for 122302.
1508E	9636	Feed Lifting Rock Shaft Screw Center Nut, for 58384.
1508E	9636	Feed Rock Shaft Screw Center Nut, for 58384.
1508J	9636	Oscillating Rock Shaft Hinge Pin Nut, for 58293 and 58586.
1508J	9636	Oscillating Rock Shaft Hinge Pin Screw Bearing Nut, for 11842 and 58566.
1513J	9632	Crank Connecting Rod Hinge Screw Nut.
1513J	9632	Feed Bar Screw Center Nut, for 56814.
1513J	9632	" Connecting Link Hinge Screw Nut.
1513J	9632	" Forked Connection Hinge Screw Nut, for 58231.
1513J	9632	Needle Bar Connecting Link Hinge Screw Nut.
1513J	9632	Oscillating Shaft Crank Slide Block Screw Stud Nut, for 19696.
1515E	9644	Bed Bracket Bolt Nut, for 507E.
1518E	4465	Lifting Presser Bar Bell Crank Slide Block Screw Nut.
1518E	4465	Lifting Presser Bar Rock Shaft Eccentric Strap Hinge Screw Nut.
1518E	4465	Thread Take-up Lever Roller and Screw Stud Nut, for 1995.
1520E	22790	Driving Attachment Lever Spring Hook Nut, for 58379 and 58508.
1522E	22790	Driving Attachment Lever Bracket Bolt Nut, for 497E.
1528C	9636	Lifting Presser Bar Rock Shaft Eccentric Strap Adjusting Screw Nut, for 11486

NUMERICAL LIST OF PARTS

No.	Plate	Name
1547D	9635	Vibrating Presser Foot Screw Nut.
1560C	9639	Tension Regulating Thumb Nut, for 58598.
1560C	9639	Thread Retaining Regulating Thumb Nut, for 58597.
1560C	9639	Thread Unwinder Tension Regulating Thumb Nut, for 42418.
1850	9636	Lifting Presser Bar Rock Shaft Crank Roller and Stud, for 11484.
1861	9636	Feed Lifting Rock Shaft Crank Roller and Stud, for 19812.
1995	9641	Thread Take-up Lever Roller and Screw Stud with 1518E, for 58296.
2002	9636	Lifting Presser Bar Rock Shaft Bracket Dowel Pin (lower).
2022	4465	Feed Lifting Rock Shaft Wearing Block Position Pin, for 19970.
2049	9635	Lifting Presser Foot Pin.
2102	4474	Thread Retaining Disc, for 11503.
2102	4474	" Unwinder Tension Disc, for 60609.
2103	4474	" Retaining Spring, for 11503.
2103	4474	" Unwinder Tension Spring, for 60609.
2117	9636	Belt Shifter Guide Rod Pin, for 11945.
2117	9636	" Slide Rod Pin, for 11945.
2117	9636	Lifting Presser Bar Rock Shaft Adjusting Arm Pin, for 58245.
2117	9636	Lifting Presser Bar Rock Shaft Crank Pin Shuttle Driver Pin.
2117	9636	Oil Cup Cover Latch Spring, for 58254.
2205	9638	Bobbin Winder Stop Latch Pin, for 60630.
2269	22789	Driving Attachment Treadle Extension Screw washer, for 126037.
2718R	4465	Lifting Presser Bar Bell Crank Slide Block Screw Nut Washer.
2718	4465	Driving Attachment Treadle Stop Collar with 362C, for 27640, obsolete.
2762	22794	Lifting Presser Bar Rock Shaft Bracket Dowel Pin (upper).
4389	9636	Lifting Presser Bar Spring Guide Pin.
4389	9636	Bobbin Winder Frame Oil Pad (felt) for 41558 and 41900.
4784	22789	Belt Shifter Chain Connecting Link, for 4885.
4879	9644	Belt Shifter Treadle, for 4885.
4881	9647	" " " Shaft, for 4885.
4882	9644	" " " Spring, for 4885.
4883	9644	" " " Stand, for 4885.
4884	9647	Belt Shifter Treadle complete for 11945, Nos. 4879, 4881 to 4884 and two wood screws 1 in. No. 16.
4885	9647	

NUMERICAL LIST OF PARTS

No.	Plate	Name
5769	4474	Thread Unwinder Tension Thread Eyelet, for 60609.....
5868	9639	Oscillating Shaft Crank Slide Block complete for 19696, Nos. 190J, 1054C, 5968 and 9119.....
5968	9639	Oscillating Shaft Crank Slide Block Cap Screw Washer, for 5868.....
5983	9639	Tension Friction Washer (felt) for 12042
6037	22787	Corder Cord Guide Bracket Rivet, for 26796.....
6055	22790	Driving Attachment Lever Spring Hook Nut Washer, for 27640, 58379 and 58508..
6439	-----	Belt Shifter Chain, 36 in. to 45 in. with 56864 and 56865, for 11945.....
8482	9638	Oil or Wax Stripper Washer (steel) for 58254.....
8702	9632	Arm Dowel Pin.....
8708	9633	" Spool Pin.....
8760	4465	Lifting Presser Bar Lifter Friction Washer.....
8761	4465	Lifting Presser Bar Lifter Stop Pin, for 11909.....
8763	4465	Lifter Presser Bar Lifting Link Hinge Stud, for 11909.....
8791	4474	Tension Spring, for 12042.....
8804	-----	Belt Shifter Frame Handle, for 11941...
8873	9641	Thread Take-up Cam Pin.....
8905	9641	Tension Regulating Thumb Nut Washer, for 12042.....
8905	9641	Thread Retaining Regulating Thumb Nut Washer, for 11503.....
8908	9649	Wrench, for 1520 (Accessories).....
8909	9649	" for 1513 (Accessories).....
8910	9649	" for 1508 (Accessories).....
3953	9638	Oil or Wax Stripper (felt) for 58254...
8961	22794	Shuttle Cylinder Hinge Pin, obsolete, use 58527.....
8973	4465	Lifting Presser Bar Lifting Link Hinge Stud Pin.....
8984	22794	Driving Attachment Brake Block (wood) for 58378 and 58464.....
8991	7851	Driving Attachment Lever Screw Washer, for 58378 and 58464.....
8992	7851	Driving Attachment Lever Spring, for 58378 and 58464.....
9079	7847	Driving Attachment Treadle Pitman Rod Clamp with 354C, obsolete, superseded by 80223, not interchangeable.....
9084	9632	Oil Cup Cover Hinge Pin, for 58254.....

NUMERICAL LIST OF PARTS

No.	Plate	Name
9091	22792	Driving Attachment Shaft Driving Pulley (sectional) 10 in. diam., 1 1/2 in. face, 1 3/16 in. bore, with two 597C, for 58379 and 58508.....
9119	9639	Oscillating Shaft Crank Slide Block, for 5868.....
9525	4474	Thread Take-up Spring Staple Washer, for 11501.....
9842	9632	Arm Shaft Screw Washer.....
9842	9632	Bobbin Winder Bracket Screw Washer, for 60272, 60275 and 60277.....
11044	4474	Tension Wheel, for 12042.....
11165	9638	Oscillating Rock Shaft Oil Pad, for 11842 and 58566.....
11241	9632	Arm Spool Pin Washer (cloth).....
11353	9643	" Shaft, for 7-34 Machine.....
11354	9633	" Bushing.....
11358	9646	Balance Wheel (two speed) with two 354C, for Stand, for 7-34 Machine.....
*11359	-----	Bed.....
11360	9645	" Bracket (right) with wood screw 1 in. No. 16 (Accessories).....
11361	9645	Bed Bracket (left) with wood screw 1 in. No. 16 (Accessories).....
11363	9634	Crank Connecting Rod with two 145E.....
11365	7851	Feed Bar.....
11367	9633	" Cam with two 445C.....
11368	4465	" Connecting Link, for 58231.....
11369	9635	" Dog, 14 teeth (10 teeth to the inch) for 11433, 26790 to 26792 and 58241..
11370	9634	Feed Forked Connection, for 58231.....
11375	9633	" Regulator, for 58231.....
11380	7851	Needle Bar.....
11383	9638	" Connecting Stud with two 445F, for 19981.....
*11385	9638	Needle Clamp Gib, for 19702.....
11393	9638	Oscillating Shaft Collar with two 453C..
11398	22794	" Rock Shaft Hinge Pin, for 58293, obsolete, superseded by 58585, not interchangeable.....
11418	9642	Shuttle Race Slide (left).....
11423	9639	Tension Friction Washer (steel) for 12042.....
11424	4474	Thread Eyelet, for 11502.....
11432	-----	Throat Plate Body, for 11433 and 58241..
11433	9635	Throat Plate complete for 11369 and 26790 to 26792, Nos. 219F, 11432 and 11434.....
11434	9635	Throat Plate Needle Plate, round needle hole, for 11433.....

NUMERICAL LIST OF PARTS

No.	Plate	Name
11435	9635	Throat Plate Needle Plate, oblong needle hole, for 58241.....
11440	9647	Driving Attachment Friction Pulley, 7 in. diam., 1 1/2 in. face, with 448C and 11441, for 58379 and 58508.....
11441	7851	Driving Attachment Friction Pulley Center Bearing, for 11440.....
11442	9634	Balance Wheel Friction Washer (paper), for 122302.....
11442	9634	Driving Attachment Balance Wheel Friction Washer (paper) for 122302.....
11446	9644	Belt Shifter Chain Eyelet, for 11945....
11447	9644	" " " Pulley, for 11945....
11450	9645	" " Guide Rod, for 11945.....
11451	9645	" " Slide Rod, for 11945.....
11453	9644	" " " " Collar with two 448C, for 11945.....
11453	9644	Belt Shifter Slide Rod Spring Collar with two 448C, for 11945.....
11475	9633	Lifting Presser Bar.....
11476	22793	" " " Bell Crank, obsolete, superseded by 58617, not interchangeable.....
11478	22793	Lifting Presser Bar Bracket with two 145E, obsolete, use 58643.....
11479	9637	Lifting Presser Bar Rock Shaft, for 58245
11480	22793	Lifting Presser Bar Rock Shaft Adjusting Arm with 453C, obsolete, use 58578..
11481	9637	Lifting Presser Bar Rock Shaft Bracket, for 58245.....
11484	9637	Lifting Presser Bar Rock Shaft Crank with 453C and 1850, for 58245.....
11486	9637	Lifting Presser Bar Rock Shaft Eccentric Strap with two each 141E and 1528C..
11487	9636	Lifting Presser Bar Rock Shaft Eccentric Strap Hinge Screw Slide.....
11488	9636	Lifting Presser Bar Rock Shaft Eccentric Strap Hinge Screw Slide Washer.....
11489	9637	Lifting Presser Bar Sleeve (lower).....
11490	9637	" " " " (upper) for 11491.....
11491	-----	Lifting Presser Bar Sleeve (upper) 11490 with 11492.....
11492	9638	Lifting Presser Bar Sleeve (upper) Cap, for 11491.....
11493	9634	Lifting Presser Bar Spring (flat).....
11495	9641	Thread Eyelet (side of arm).....
11496	9635	Lifting Presser Foot with 211F.....
11500	9642	Shuttle Race Slide (right).....

NUMERICAL LIST OF PARTS

No.	Plate	Name
11501	-----	Tension Bracket and Vibrating Presser Bar Cap complete, Nos. 122E, 9525, 11502, 11506, 11936, 11937, 12042 and two 190J.....
11502	9642	Tension Bracket and Vibrating Presser Bar Cap with 11424, for 11501.....
11503	-----	Thread Retainer complete, Nos. 2103, 8905, 58597 and two 2102.....
11505	9642	Thread Take-up Cam with two 434C.....
11506	4474	" " Spring, for 11501.....
11508	9642	Vibrating Presser Bar.....
11509	9641	" " " Cushion (rawhide).
11510	22793	" " " Hinge Bracket with 145E, for 7-9 and 7-34 Machines, obsolete, superseded by 58620, not interchangeable.....
11512	9642	Vibrating Presser Bar Spring.....
11513	9635	" " Foot, for 26791.....
*11539	9637	Needle Bar Connecting Link, for 19981...
11831	9649	Screw Driver (large) Accessories.....
11832	9637	Shuttle Race Back, for 11836.....
11833	9639	" " " Position Pin, for 11836
11835	-----	" " Body, for 11836.....
11836	9634	Shuttle Race complete, Nos. 32D, 11832, 11835, 19577 and two 11833.....
11837	9634	Shuttle Race Frame with 11838.....
11838	9639	" " " Position Pin, for 11837
*11841	22793	Oscillating Rock Shaft (steel) for 11842, obsolete, superseded by 58573; not interchangeable.....
11842	-----	Oscillating Rock Shaft complete, Nos. 622C, 1508J, 11165, 11841 and 58293, obsolete, superseded by 58566, not interchangeable.....
11848	-----	Oscillating Shaft Crank, for 19696.....
11850	9634	" Shaft.....
11853	22794	Shuttle Cylinder Latch, for 58212, obsolete, superseded by 58626, not interchangeable.....
11856	9637	Shuttle Driver with 453C.....
11878	9643	Arm Shaft, for 7-48 Machine.....
11907	7851	Lifting Presser Bar Lifting Link.....
11909	9633	" " " Lifter with 8761 and 8763.....
11910	9640	Shuttle Bobbin, for 19980 and 58525.....
11913	9633	Arm Side Cover.....
11917	7847	Oil Cup Cover, for 58254.....
11918	9638	Oil or Wax Stripper Washer (steel) for 58254.....

NUMERICAL LIST OF PARTS

No.	Plate	Name
11927	9635	Lifting Presser Foot with 211F, for 26791
11936	4474	Thread Take-up Spring Regulator Plate, for 11501.....
11937	4474	Thread Take-up Spring Staple, for 11501.
11939	9641	Vibrating Presser Bar Spring Adjusting Staple.....
11940	9643	Belt Shifter Fork, for 11945.....
11941	9643	" " Frame with 8804 and two 434C, for 11945.....
11942	9645	Belt Shifter Slide Rod Spring, for 11945
11945	-----	Belt Shifter complete for 7-48 Machine, Nos. 567D, 4885, 6439, 11446, 11447, 11450, 11451, 11940 to 11942, 58408, 58409 and two each 2117 and 11453.....
11950	4474	Thread Eyelet, for 11503.....
12002	9640	Shuttle Cylinder Latch Pin, for 58212 and 58524.....
12042	-----	Tension (wheel) complete, for 11501, Nos. 8791, 8905, 11044, 11423, 58598 and two 5983.....
14592	9650	Vibrating Presser Bar, for 26799.....
14785	22790	Driving Attachment Lever Spring Hook, for machine on top of table, for 58379 and 58508.....
*15404	-----	Trade Mark, for 19502.....
15405	-----	Bobbin Winder Friction Pulley Ring Rivet, obsolete, use 26070.....
15405	-----	Trade Mark Rivet, for 19502.....
17547	4474	Thread Unwinder Tension Thread Guard, for 60609.....
*19502	-----	Arm with 15404 and two 15405.....
19577	7851	Shuttle Race Back Spring, for 11836.....
19662	22791	Driving Attachment Lever, for 58378, obsolete, use 58463.....
19663	22792	Driving Attachment Lever Bracket, for 58378, obsolete, use 58462.....
19696	9639	Oscillating Shaft Crank complete, Nos. 453C, 1513J, 5868 and 11848.....
19702	9638	Needle Clamp with 680F and 11385.....
19712	22786	Lifting Presser Foot with 211F for cloth, for 26790 and 26792.....
19713	22786	Lifting Presser Foot with 211F for leather, for 26790 and 26792.....
19714	22786	Lifting Presser Foot with 211F for 26800
19715	22786	" " " " 211F " 26799
19716	22786	Vibrating Presser Foot, for 26790 and 26792.....
19717	22786	Vibrating Presser Foot, for 26799 and 26800.....

NUMERICAL LIST OF PARTS

No.	Plate	Name
19812	9633	Feed Lifting Rock Shaft Crank with 346E and 1861, for 19971.....
19863	22790	Driving Attachment Lever Spring Hook (for machine flush with table).....
19869	22794	Shuttle Cylinder Latch Spring, for 58212, obsolete, superseded by 122419, not interchangeable.....
19967	4465	Feed Lifting Rock Shaft Wearing Block, for 19970.....
19970	7847	Feed Lifting Rock Shaft with 134D, 2022 and 19967, for 19971.....
19971	-----	Feed Lifting Rock Shaft complete, Nos. 19812 and 19970.....
19977	9640	Shuttle Cylinder, for 58213.....
19978	22794	" Frame, for 58212, obsolete, superseded by 58523, not interchangeable.
19979	9639	Shuttle Tension Spring, for 58213.....
19980	22794	Shuttle (cylinder) 3 in. diam., complete, Nos. 11910, 58212, 58213 and 58527, obsolete, superseded by 58525, not interchangeable.....
19981	-----	Needle Bar Connecting Stud 11383 with 11539.....
23258	22790	Driving Attachment Treadle Bracket (left) Hook Friction Washer, for 126206....
23535	9649	Wrench, for 346, 1528 and 1547 (Accessories).....
25362	9632	Balance Wheel Ball, size 3/16 in., for 122304.....
25362	9632	Driving Attachment Balance Wheel Ball, size 3/16 in., for 122304.....
25881	7847	Guide (6 in. face).....
26026	9649	Screw Driver (small) Accessories.....
26070	22789	Bobbin Winder Friction Pulley Ring Rivet, for 43270.....
26509	22786	Vibrating Presser Foot, for 14592.....
26790	9650	Binder on Shank, for harness housings...
26791	9650	" " " for binding leather....
26792	9650	" " " for harness work.....
26794	9650	Lap Seam Feller (left hand) on Shank, to fold top only.....
26795	22787	Corder Cord Guide, for 26799.....
26796	22787	Corder Cord Guide Arm with 26798 and three 6037, for 26799.....
26797	22787	Corder Cord Guide Bed, for 26799.....
26798	22787	" " " Bracket, for 26796....
26799	22787	Corder (adjustable) complete, for buggy cushions, Nos. 190J, 1044D and 26795 to 26797.....

NUMERICAL LIST OF PARTS

No.	Plate	Name
26800	9650	Piping Attachment on Shank.....
26900	7853	Hemmer on Shank, for canvas.....
27555	3582	Thread Unwinder Spool Pin, for 27556 and 41451.....
27556	-----	Thread Unwinder Spool Rest 27583 with 138B and two 27555, for 41823 and 60637.....
27557	3582	Thread Unwinder Spool Stand with 138B, for 41454 and 41823.....
27560	3582	Thread Unwinder Thread Guard Rod, 26 in. long, for 41454 and 41823.....
27583	7285	Thread Unwinder Spool Rest, for 27556...
27637	7847	Driving Attachment Treadle Pitman Rod (lower) for 27640, obsolete.....
27639	9647	Driving Attachment Treadle Pitman Rod, for 27640 and 60626.....
27640	7847	Driving Attachment Treadle Pitman complete for 126210, Nos. 2762, 6055, 27637, 27639, 80223 and 150208, obsolete, superseded by 60626, not interchangeable.....
27693	22791	Thread Unwinder Thread Guard Rod, 37 in. long, for 60637.....
27916	22789	Bobbin Winder Brake (leather), for 41439
28084	22789	" " " Rivet, for 41439....
40025	9639	Oscillating Shaft Crank Pin.....
41398	22789	Bobbin Winder Bobbin Carrier Key, for 41444.....
41439	22788	Bobbin Winder Base with 458C, 27916 and two 28084, for 41558.....
41440	22788	Bobbin Winder Frame, for 41558.....
41441	22789	" " " Hinge Pin, for 41558 and 41900.....
41442	22789	Bobbin Winder Frame Spring, for 41558...
41443	22788	" " Pulley with 155C, for 41558
41444	22788	" " Spindle with 41398, for 41558.....
41446	6781	Bobbin Winder Stop Latch Hinge Pin, for 60630.....
41447	22789	Bobbin Winder Tripping Arm with 176E, for 41558.....
41450	3582	Thread Unwinder Spool Rest, for 41451...
41451	-----	" " " 41450 with 138B and 27555, for 41454.....
41454	3582	Thread Unwinder complete for one large spool, for 41559, Nos. 27557, 27560, 41451, 41514, 60609 and three wood screws 1 1/4 in. No. 12.....
41514	3582	Thread Unwinder Spool Weight, 4 in. diam., with 41515, for 41454.....

NUMERICAL LIST OF PARTS

No.	Plate	Name
41515	22789	Thread Unwinder Spool Weight Center Pin, for 41514.....
41544	9641	Lap Seam Feller Screw Washer, for 26794.
41544	9641	Vibrating Presser Bar Hinge Cap Screw Washer.....
41557	6781	Bobbin Winder Stop Latch, for 60630.....
41558	22788	Bobbin Winder, for 41559 and 41824, Nos. 41439 to 41444, 41447, 60630, two 4784 and three wood screws 1 in. No. 7...
41559	-----	Bobbin Winder (swinging automatic, right hand) complete, for flat or round belt, for 11910, Nos. 41454 and 41558
41823	7285	Thread Unwinder complete, for two large spools, for 41824, 60272, 60275 and 60277, Nos. 27556, 27557, 27560, 60609 and three wood screws 1 1/4 in. No. 12
41824	-----	Bobbin Winder (swinging automatic, right hand) complete, for flat or round belt, for 11910, Nos. 41558 and 41823
41894	6781	Bobbin Winder Base with 449C, for 41900.
41895	22789	" " Bobbin Carrier Key, for 41898.....
41896	7851	Bobbin Winder Frame, for 41900.....
41897	7851	" " " Spring, for 41900..
41898	6781	" " Spindle with 41895, for 41900
41899	22789	" " Tripping Arm with 176E, for 41900.....
41900	6781	Bobbin Winder for 60272, 60275 and 60277, Nos. 41441, 41894, 41896 to 41899, 43270, 60630 and two 4784.....
42418	-----	Thread Unwinder Tension Screw Stud 828C with 1560C, for 60609.....
43267	4465	Lifting Presser Bar Lifting Link Hinge Stud Washer.....
43270	22788	Bobbin Winder Friction Pulley with 43271, two 448C and ten 26070, for 41900...
43271	22788	Bobbin Winder Friction Pulley Ring (leather) for 43270.....
46681	-----	Driving Attachment Treadle Bracket (right) for 60502.....
50083C	9638	Lifting Presser Bar Bell Crank Hinge Stud Set Screw.....
50124D	22789	Bobbin Winder Bracket Screw, for 60272, 60275 and 60277.....
50322D	9636	Feed Regulator Thumb Screw, for 58231...
50323D	9638	Lifting Presser Bar Spring Regulating Thumb Screw.....
50348E	9632	Arm Screw
50437D	9641	Thread Take-up Lever Hinge Screw, for 58320.....

NUMERICAL LIST OF PARTS

No.	Plate	Name
50581R	22790	Driving Attachment Treadle Extension Screw, for 126037.....
51224W	9648	Binder Guide Thumb Screw, for 120233 and 120304.....
51237C	9638	Oscillating Rock Shaft Hinge Pin Screw Bearing, for 58566.....
*56814	-----	Feed Bar Screw Center 307C with 1513J...
56864	9644	Belt Shifter Chain Hook (large) for 6439
56865	9644	" " " " (small) for 6439
58212	-----	Shuttle Frame 19978 with 11853,12002 and 19869, for 19980, obsolete, superseded by 58524, not interchangeable.....
58213	-----	Shuttle Cylinder 19977 with 773F and 19979, for 19980 and 58525.....
*58231	-----	Feed Forked Connection 11370 with 11368, 11375, 50322D and two each 565C and 1513J.....
58233	7847	Feed Rock Shaft, for 58234.....
58234	-----	Feed Rock Shaft complete, Nos. 58233 and 58235.....
58235	4465	Feed Rock Shaft Crank with 346E, for 58234.....
58241	-----	Throat Plate complete for 11369 and 26790 to 26792, Nos. 219F, 11432 and 11435.....
*58245	-----	Lifting Presser Bar Rock Shaft Bracket 11481 with 2117, 11479, 11484 and 58578.....
58252	7851	Lifting Presser Bar Spring Bracket.....
58253	-----	Oil Cup, for 58254.....
58254	7847	Oil Cup complete, Nos. 2205, 8482, 9084, 11917, 11918, 58253, two 8953 and three 207F.....
58263	22793	Table Belt Guide Bracket with 448C, for 58268.....
58264	22793	Table Belt Guide Pulley, for 58268.....
58265	22793	Table Belt Guide Pulley Shaft with 58266 and 58267, for 58268.....
58266	22794	Table Belt Guide Pulley Shaft Oil Hole Plug, for 58265.....
58267	-----	Table Belt Guide Pulley Shaft Packing (wick) for 58265.....
58268	-----	Table Belt Guide complete, for flat belt, for power table, Nos. 58264, 58265, two 58263 and eight wood screws 1 1/2 in. No. 14 R.H.....
*58293	-----	Oscillating Rock Shaft Hinge Pin 11398 with 1508J, for 11842, obsolete, superseded by 58586, not interchangeable.

NUMERICAL LIST OF PARTS

No.	Plate	Name
58295	-----	Thread Take-up Lever, for 58296
58296	7851	" " " 58295 with 1995, for 58320.
58320	-----	Thread Take-up Lever 58296 with 50437D...
58329	7847	Arm Shaft, for 7-9 Machine.....
58378	-----	Driving Attachment Lever 19662 with 9D, 134D, 8984, 8991, 8992, 19663 and two 497E, for 58379, obsolete, superseded by 58464, not interchangeable.....
58379	-----	Driving Attachment complete for 58329, for 7-9 Machine, Nos. 1520E, 6055, 9091, 11440, 14785, 58378, 122302, 122304, 122306 and 126210, obsolete, superseded by 58508, not interchangeable.
58384	-----	Feed Lifting Rock Shaft Screw Center 564C with 1508E.....
58384	-----	Feed Rock Shaft Screw Center 564C with 1508E
58407	9643	Balance Wheel and Pulley (tight), with two 354C, for 7-48 Machine.....
58408	9647	Belt Shifter Pulley (loose) for 11945..
58409	9645	" " " " Flanged Bush- ing with two 435C, for 11945.....
58411	9646	Balance Wheel with two 354C, for Under Driver, for 7-34 Machine.....
58458	22790	Driving Attachment Brake Block Stud, for 58463.....
58462	9647	Driving Attachment Lever Bracket, for 58464.....
58463	22791	Driving Attachment Lever with 1036C and 58458, for 58464.....
58464	-----	Driving Attachment Lever 58463 with 134D, 8984, 8991, 8992, 58462 and two 497E, for 58508.....
58508	-----	Driving Attachment complete for 58329, for 7-9 Machine, Nos. 1520E, 6055, 9091, 11440, 14785, 58464, 122302, 122304, 122306 and 126212.....
58523	9640	Shuttle Frame, for 58524.....
58524	-----	Shuttle Frame 58523 with 12002, 58626, and 122419, for 58525.....
58525	9640	Shuttle (cylinder) 3 in. diam., complete, Nos. 11910, 58213, 58524 and 58527.....
58527	9640	Shuttle Cylinder Hinge Pin, for 19980 and 58525.....
58566	-----	Oscillating Rock Shaft complete, Nos. 1508J, 11165, 51237C, 58570, 58573 and 58586.....
58567	9639	Oscillating Rock Shaft Oil Tube with 58569, for 58570.....

No.	Plate	Name
58568	9639	Oscillating Rock Shaft Oil Tube Joint, for 58570.....
*58569	-----	Oscillating Rock Shaft Oil Tube Sleeve, for 58567.....
58570	9639	Oscillating Rock Shaft Oil Tube complete for 58566, Nos. 58567, 58568 and 127848
58573	9637	Oscillating Rock Shaft, for 58566.....
58578	9637	Lifting Presser Bar Rock Shaft Adjusting Arm with 453C, for 58245.....
58585	9637	Oscillating Rock Shaft Hinge Pin, for 58586.....
58586	-----	Oscillating Rock Shaft Hinge Pin 58585 with 1508J, for 58566.....
58597	-----	Thread Retaining Screw Stud 606E with 1560C, for 11503.....
58598	-----	Tension Screw Stud 607E with 1560C, for 12042.....
58617	9633	Lifting Presser Bar Bell Crank.....
58618	9638	Lifting Presser Bar Bell Crank Hinge Stud.....
58619	9638	Lifting Presser Bar Bell Crank Slide Block, for 58621.....
58620	9642	Vibrating Presser Bar Hinge Bracket with 145E, for 7-9 and 7-34 Machines.....
58621	-----	Lifting Presser Bar Bell Crank Slide Block 58619 with 610D.....
58626	9640	Shuttle Cylinder Latch, for 58524.....
58643	9633	Lifting Presser Bar Bracket with two 145E.....
58659	9645	Vibrating Presser Bar Hinge Bracket with 145E, for 7-48 Machine.....
60227	9647	Bobbin Winder Bracket, for 60277.....
60271	9647	" " " " 60272.....
60272	-----	Bobbin Winder (swinging automatic, left hand) complete, for 11910, for 122302, for 7-9 Machine, Nos. 9842, 41823, 41900, 50124D, 60271 and three 894D.
60274	9647	Bobbin Winder Bracket, for 60275.....
60275	-----	Bobbin Winder (swinging automatic, left hand) complete, for 11910, for 58407, for 7-48 Machine, for 58411, for 7-34 Machine, Nos. 9842, 41823, 41900, 50124D, 60274 and three 894D.....
60277	-----	Bobbin Winder (swinging automatic, left hand) complete, for 11910, for 11358, for 7-34 Machine, Nos. 9842, 41823, 41900, 50124D, 60227 and three 894D.
60502	-----	Driving Attachment Treadle Bracket (right) 46681 with two wood screws, 1 in. No. 14, for 126209 and 126211..

No.	Plate	Name
60608	3582	Thread Unwinder Thread Guard, for 60609.
60609	-----	Thread Unwinder Thread Guard complete for 41454, 41823 and 60637, Nos. 330E, 2103, 5769, 17547, 42418, 60609 and two 2102.....
60626	9647	Driving Attachment Treadle Pitman complete for 126212, Nos. 80223 and two 27639.....
*60630	-----	Bobbin Winder Stop Latch 41557 with 2269 and 41446, for 41558 and 41900.....
60636	22792	Thread Unwinder Holder with 139B, for 60637.....
60637	-----	Thread Unwinder complete, for two large spools of thread, for 5201, for 25207, Nos. 27556, 27693, 60609, 60636 and two wood screws 1 1/4 in. No. 12.....
60858	22790	Driving Attachment Treadle Hanging Hook, for 126212.....
80223	9647	Driving Attachment Treadle Pitman Rod Clamp with 361C, for 27640 and 60626
120192	7853	Hemmer on Shank, for heavy canvas, for 7-9 Machine.....
120229	9648	Binder Bed with two each 1036C and 1266C, for 120233 and 120304.....
120230	9648	Binder Edge Guide, for 120233 and 120304
120231	9648	Binder Guide (lower) for 120233.....
120232	9648	" " (upper) for 120233.....
120233	9648	Binder (adjustable) complete for turning in both edges of imitation leather binding, for heavy material, for 7-34 Machine, Nos. 671D, 51224W and 120229 to 120232.....
120302	7853	Binder Guide (lower) for 120304.....
120303	7853	" " (upper) for 120304.....
120304	-----	Binder (adjustable) complete for turning in both edges of imitation leather binding, for heavy material, for 7-9 and 7-34 Machines, Nos. 671D, 51224W, 120229, 120230, 120302 and 120303...
120344	9649	Oiler (copper plated) with 120345 (Accessories).....
120345	9649	Oiler Spout, 4 1/2 in. long, for 120344.
120571	9640	Shuttle (cylinder) Opener (Accessories).
122301	9634	Balance Wheel with two 354C, for 122302.
122301	9634	Driving Attachment Balance Wheel with two 354C, for 122302.....
122302	-----	Balance Wheel 122301 with 11442, 122469, two 1402E and four 401E, for 7-9 Machine.....

NUMERICAL LIST OF PARTS

No.	Plate	Name
122302	-----	Driving Attachment Balance Wheel 122301 with 11442, 122469, two 1402E and four 401E, for 58379 and 58508.....
*122303	-----	Balance Wheel Ball Ring, for 122304.....
*122303	-----	Driving Attachment Balance Wheel Ball Ring, for 122304.....
122304	7851	Balance Wheel Ball Ring 122303 with eighteen 25362, for 7-9 Machine.....
122304	7851	Driving Attachment Balance Wheel Ball Ring 122303 with eighteen 25362, for 58379 and 58508.....
122306	7851	Balance Wheel Ball Washer (left) for 7-9 Machine.....
122306	7851	Driving Attachment Balance Wheel Ball Washer (left) for 58379 and 58508..
122307	7851	Balance Wheel Ball Washer (right), obsolete, superseded by 122469, not interchangeable.....
122419	9640	Shuttle Cylinder Latch Spring, for 58524
122469	9632	Balance Wheel Ball Washer (right) for 122302.....
122469	9632	Driving Attachment Balance Wheel Ball Washer (right) for 122302.....
126036	22792	Driving Attachment Treadle, for 126037 and 126209.....
126037	-----	Driving Attachment Treadle 126036 with 2718R, 50581R and 126038, for 126211
126038	9647	Driving Attachment Treadle Extension, for 126037.....
126205	-----	Driving Attachment Treadle Bracket(left) for 126206.....
126206	-----	Driving Attachment Treadle Bracket (left) complete for 126209 and 126211, Nos. 23258, 126205, 126207, 126208 and two wood screws 1 in. No. 14.....
126207	22790	Driving Attachment Treadle Bracket (left) Hook, for 126206.....
126208	22790	Driving Attachment Treadle Bracket (left) Hook Rivet, for 126206.....
126209	-----	Driving Attachment Treadle complete, for 126210, Nos. 60502, 126036 and 126206, obsolete, superseded by 126211, not interchangeable.....
126210	-----	Driving Attachment Treadle and Pitman complete, for 58379, Nos. 27640 and 126209, obsolete, superseded by 126212, not interchangeable.....
126211	-----	Driving Attachment Treadle complete, for 126212, Nos. 60502, 126037 and 126206

NUMERICAL LIST OF PARTS

No.	Plate	Name
126212	-----	Driving Attachment Treadle and Pitman complete for 58508, Nos. 60626, 60858 and 126211.....
127648	9639	Oscillating Rock Shaft Oil Tube Oil Cup, for 58570.....
150208	22794	Driving Attachment Treadle Pitman Rod (lower) Spring, for 27640, obsolete.

Genuine Singer Needles should be used in Singer Machines.
These Needles and their Containers are marked with the Company's Trade Mark "SIMANCO." 1

Needles in Containers marked "For Singer Machines" are not Singer made needles. 2

PLATE 3582—ONE-FOURTH SIZE

41454

60608

27560

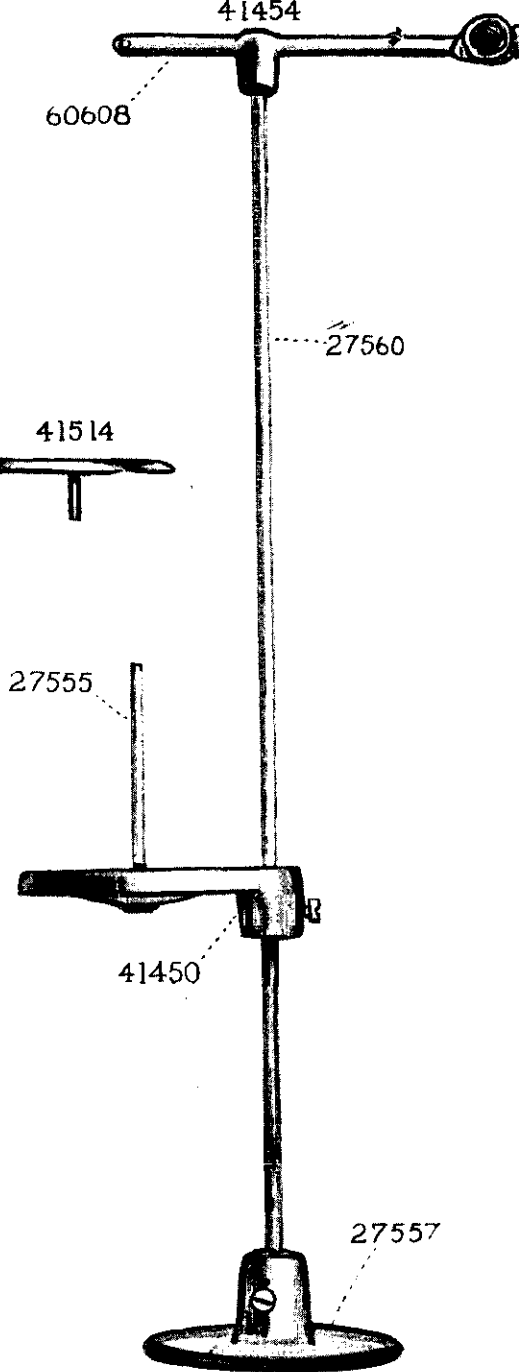
41514



27555

41450

27557



Genuine Singer Needles should be used
in Singer Machines.
These Needles and their Containers
are marked with the
Company's Trade Mark "SIMANCO." 1

Needles in Containers marked
"For Singer Machines"
are not Singer made needles. 2

PLATE 4465—FULL SIZE

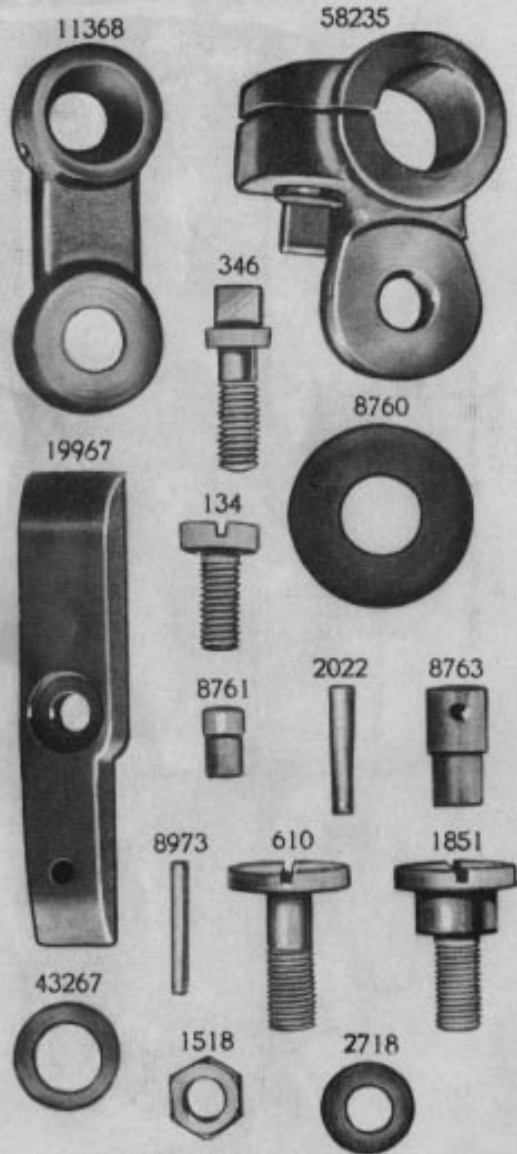
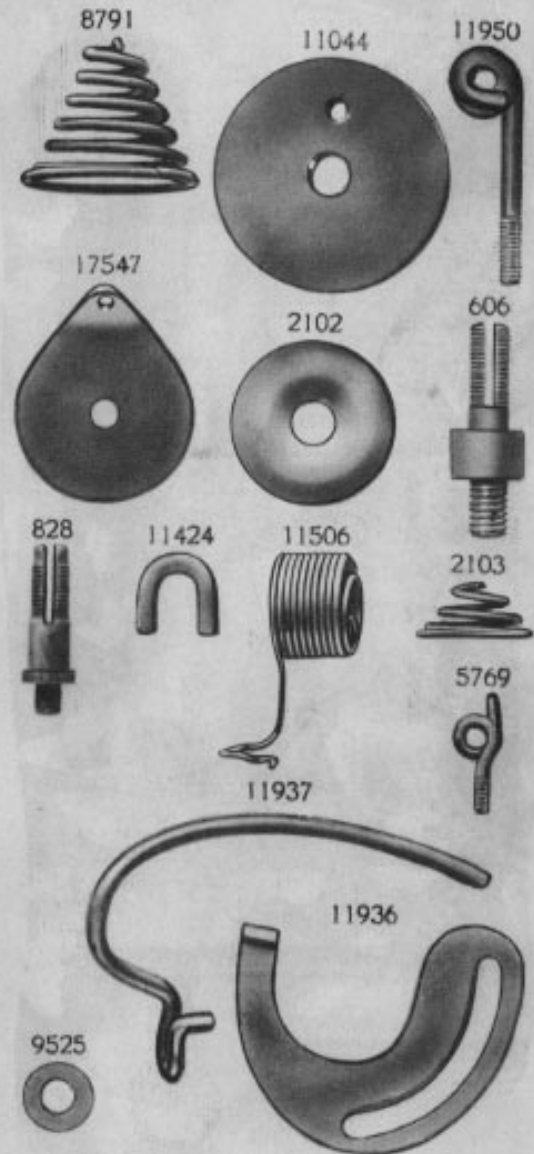


PLATE 4474—FULL SIZE



From the library of: Diamond Needle Corp

PLATE 6781—ONE-HALF SIZE

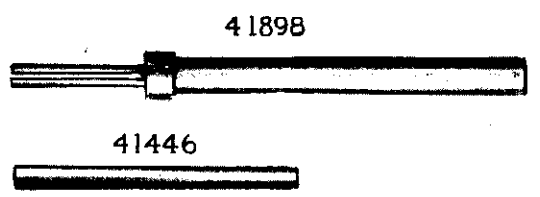
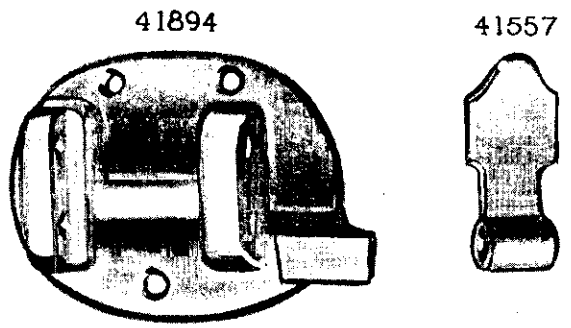
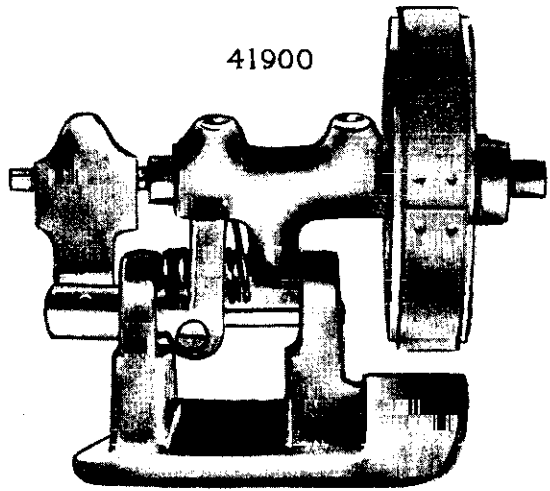
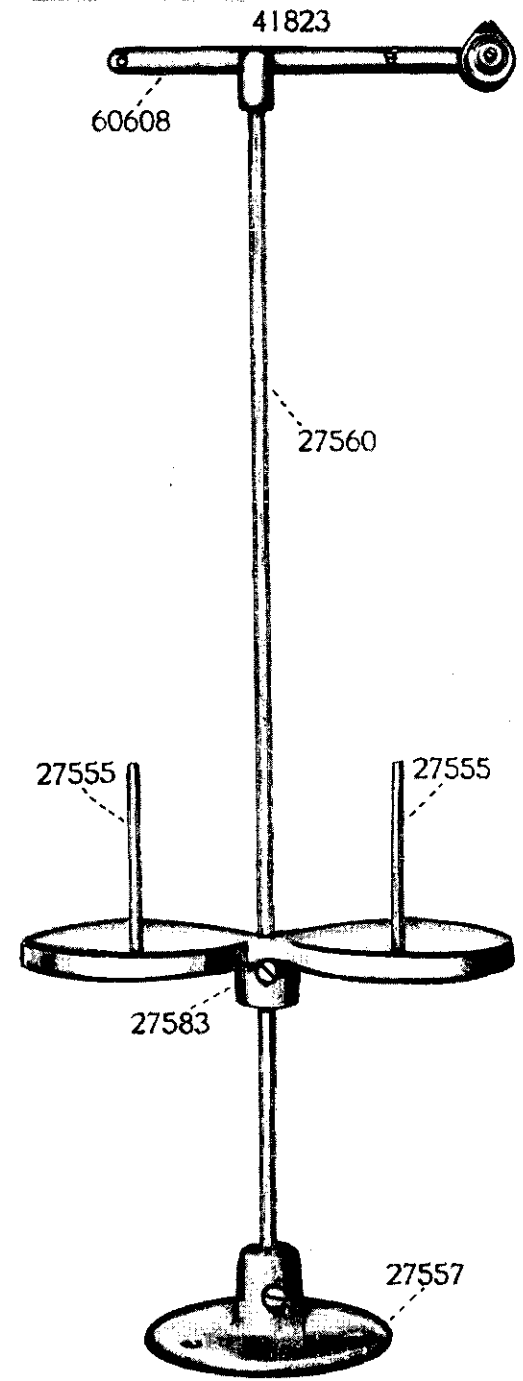


PLATE 7285—ONE-FOURTH SIZE



1930 SIG. U. S. PAT. 3

From the library of: Diamond Needle Corp

PLATE 7847—ONE-FOURTH SIZE

58329 58233 19970 27640

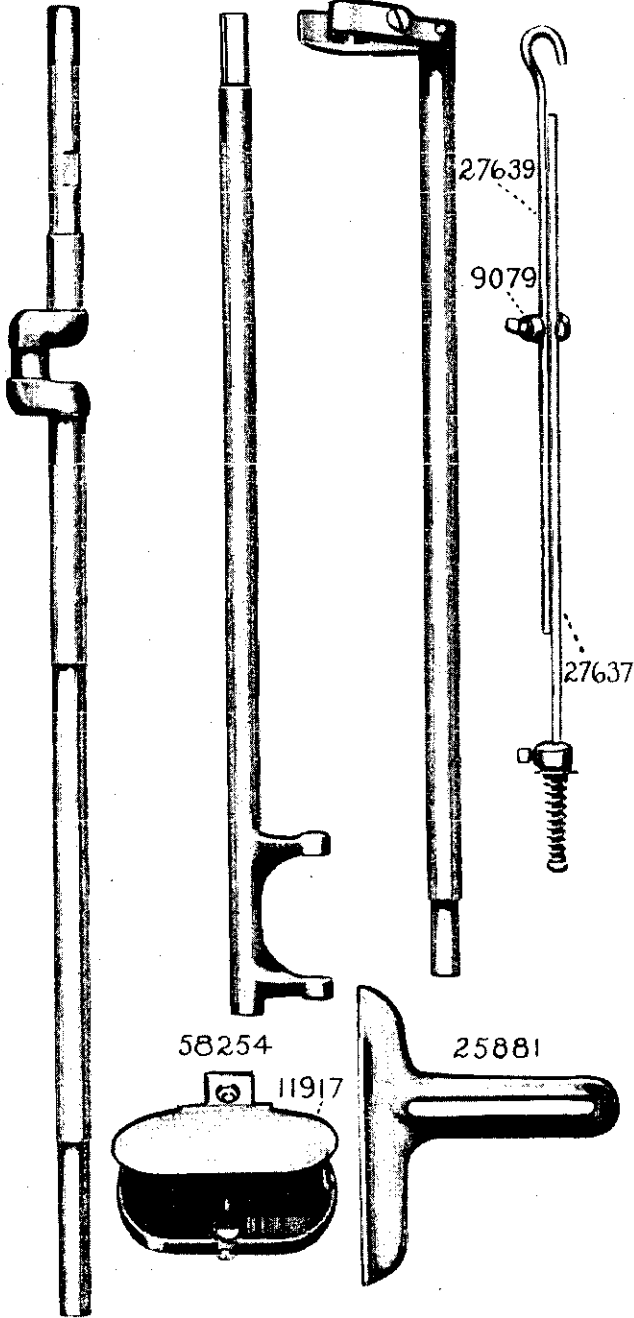


PLATE 7851—ONE-HALF SIZE

11380 11365 58296 11907

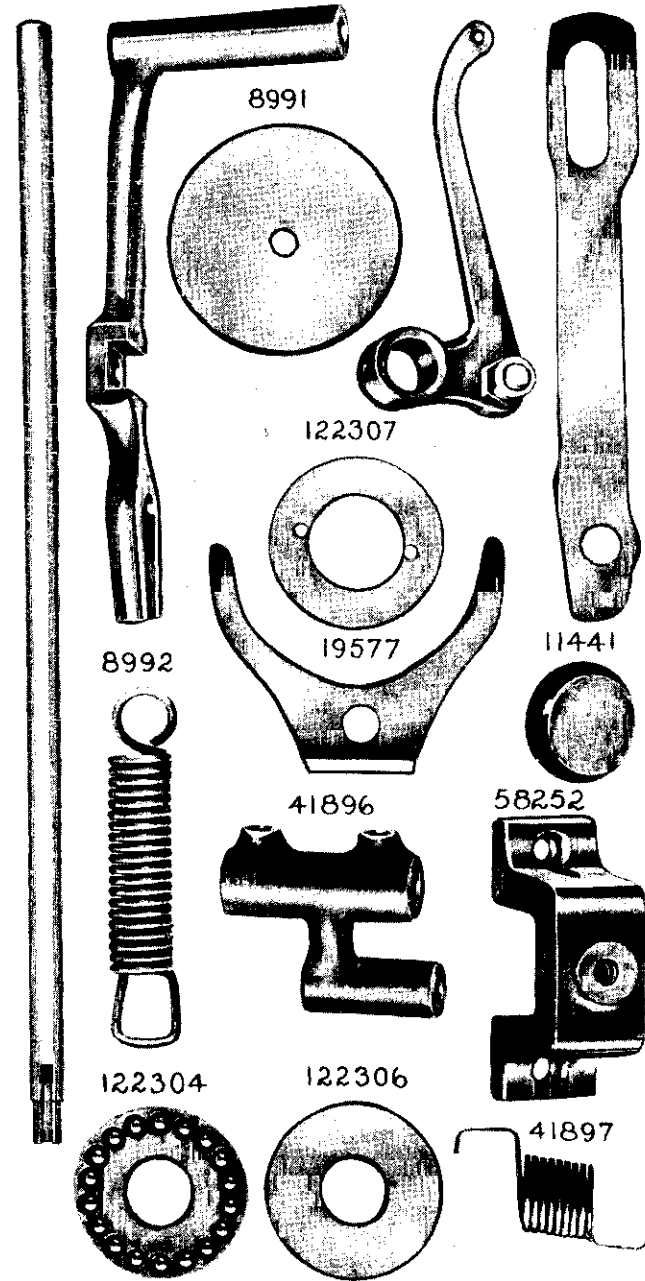


PLATE 7853—ONE-HALF SIZE

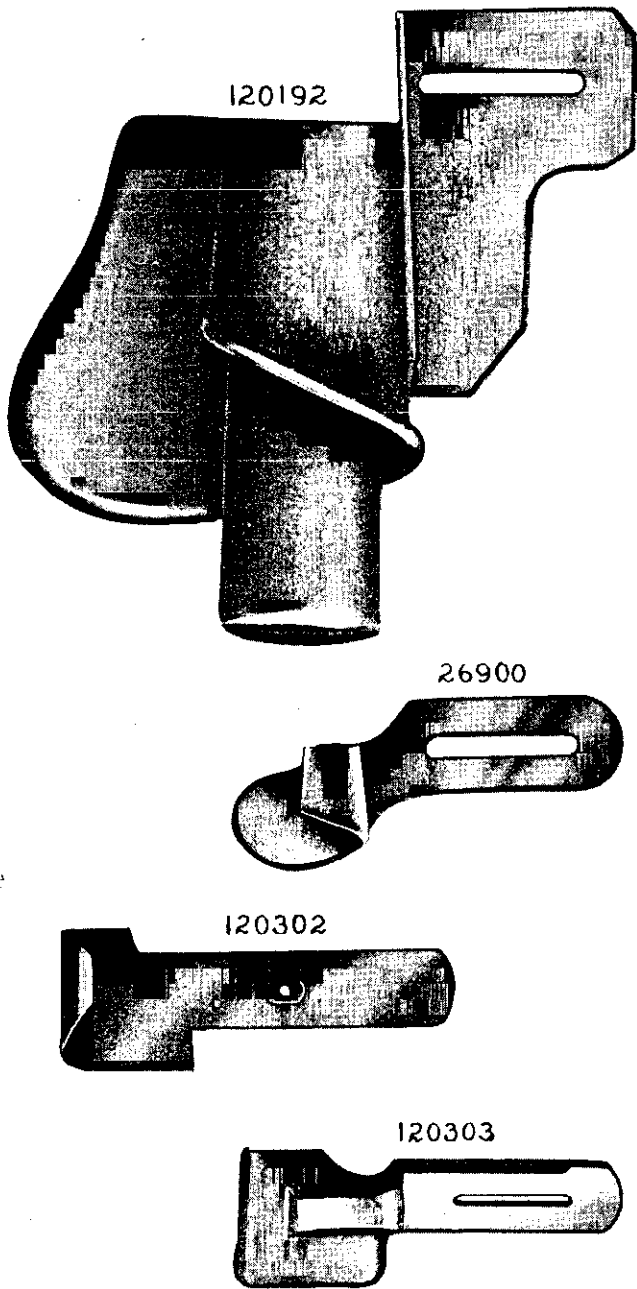


PLATE 9632 - FULL SIZE

122469

11241

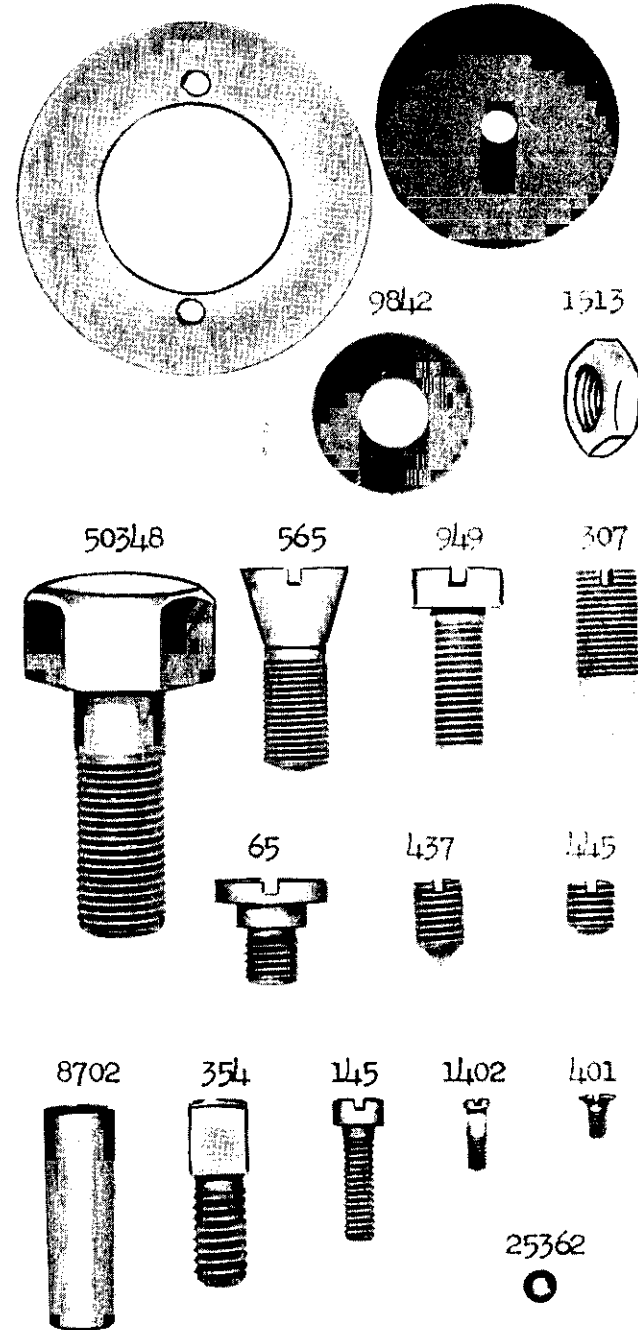


PLATE 9633 - ONE-HALF SIZE

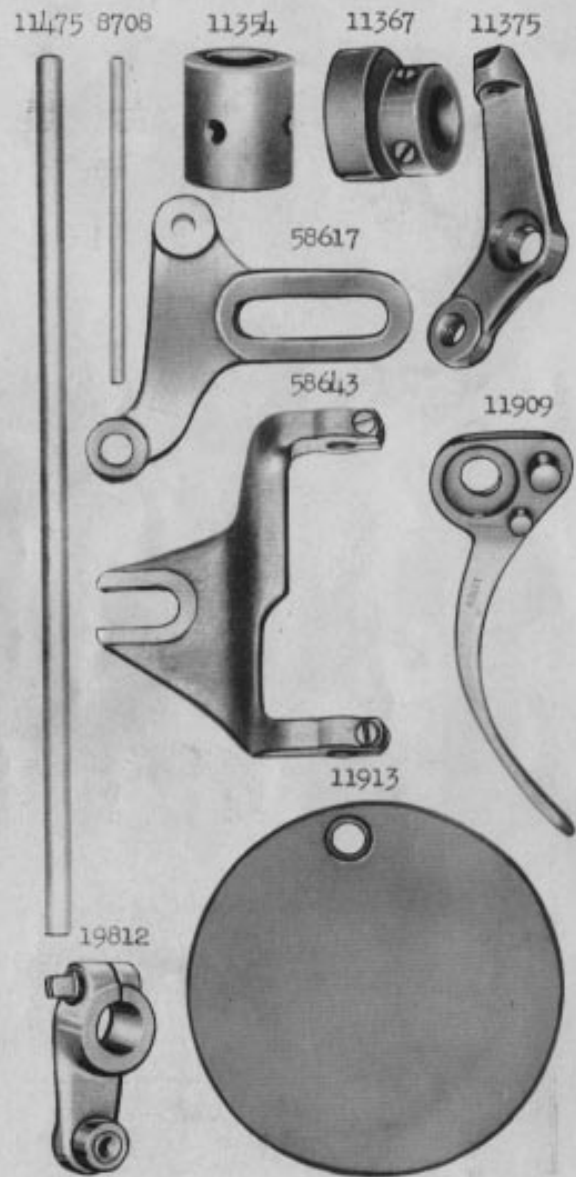
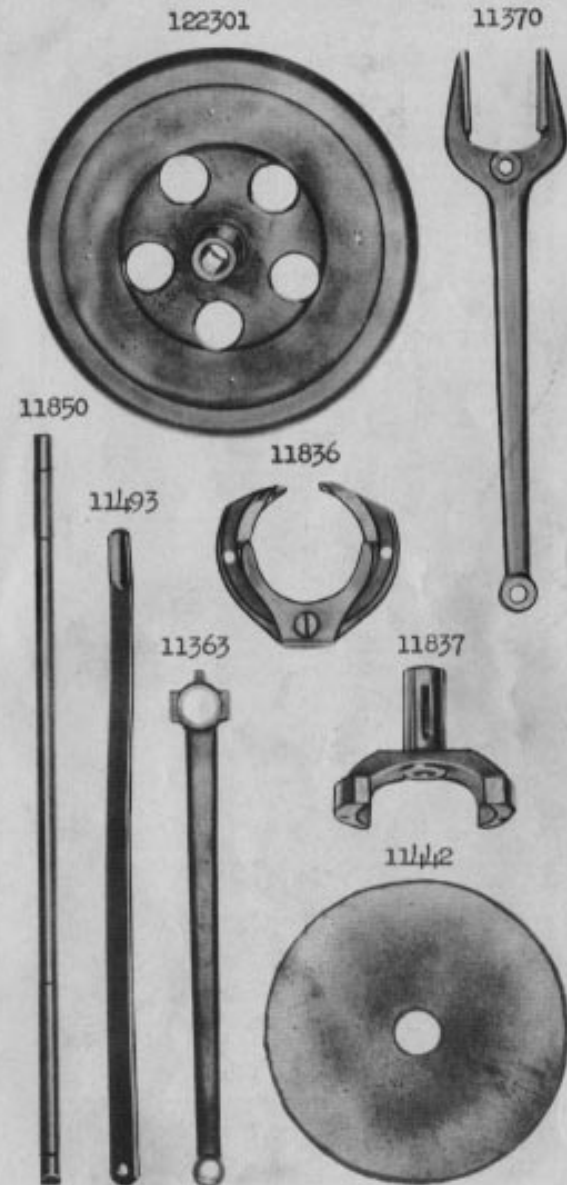


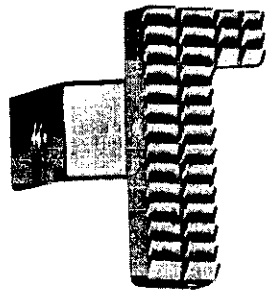
PLATE 9634 - ONE-FOURTH SIZE



From the library of: Diamond Needle Corp

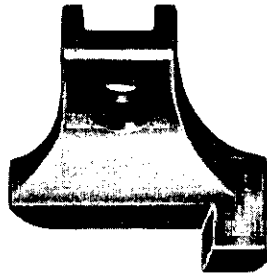
PLATE 9635 - FULL SIZE

11369



10 teeth = 1 inch

11513



211



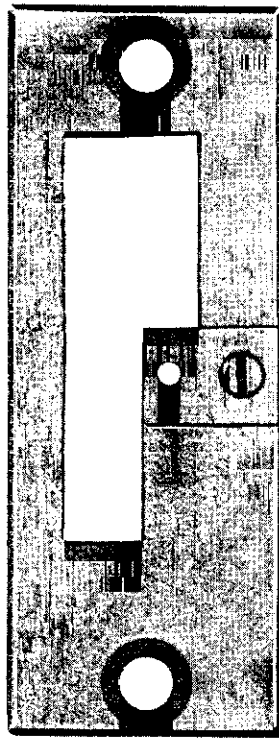
219



1547



11433



11496



11927



2049



11434



11435



898



166

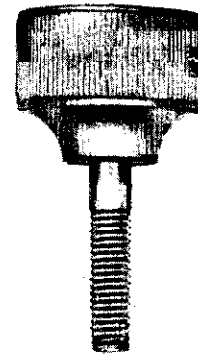


381

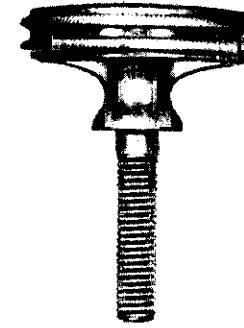


PLATE 9636 - FULL SIZE

50322



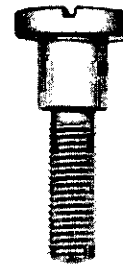
254



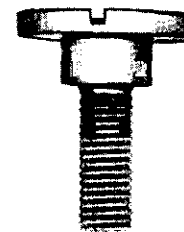
564



608



16



568



123



141



2117



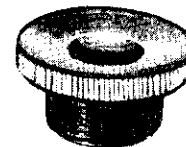
4389



2002



258



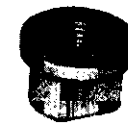
1861



1850



11487



1508



11488



453

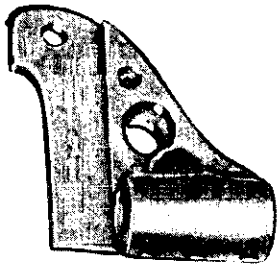


1528

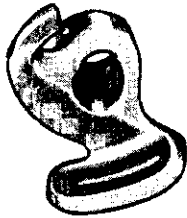


PLATE 9637 - ONE-HALF SIZE

11481

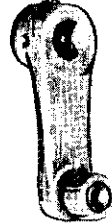
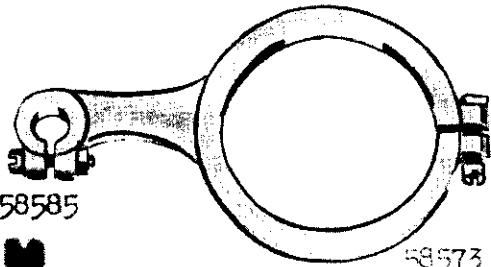


11856



11486

11484

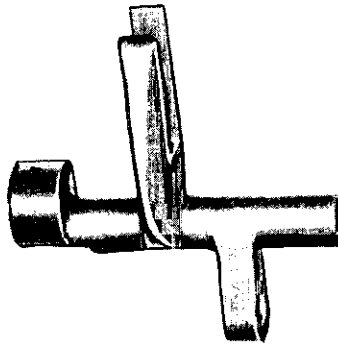
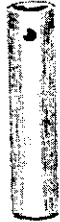
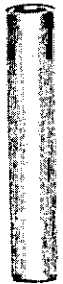


58585

58573

11489

11490



58578

11539

11479

11832

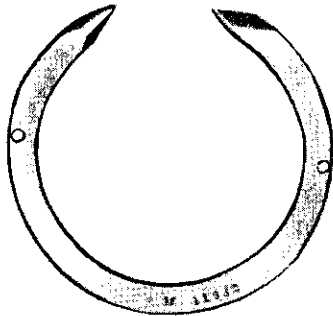


PLATE 9638 - FULL SIZE

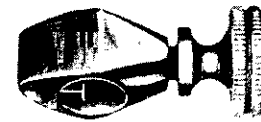
50323



51237



19702



8953



9084



566



680



1177



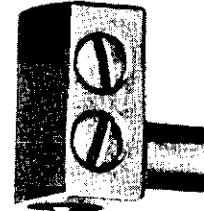
50083



58618



11383



2205



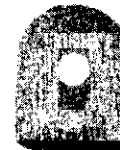
58619



11492



11918



11165



11393



11385



8482



207



PLATE 9639 - FULL SIZE

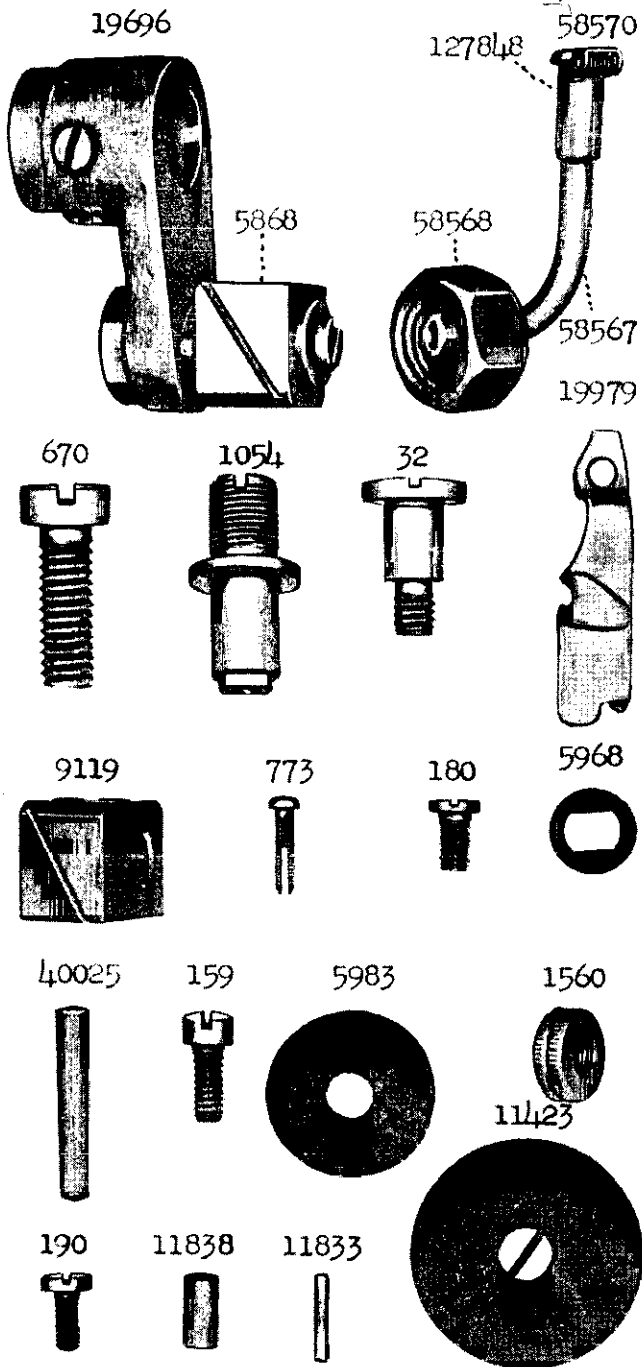


PLATE 9640 - FULL SIZE

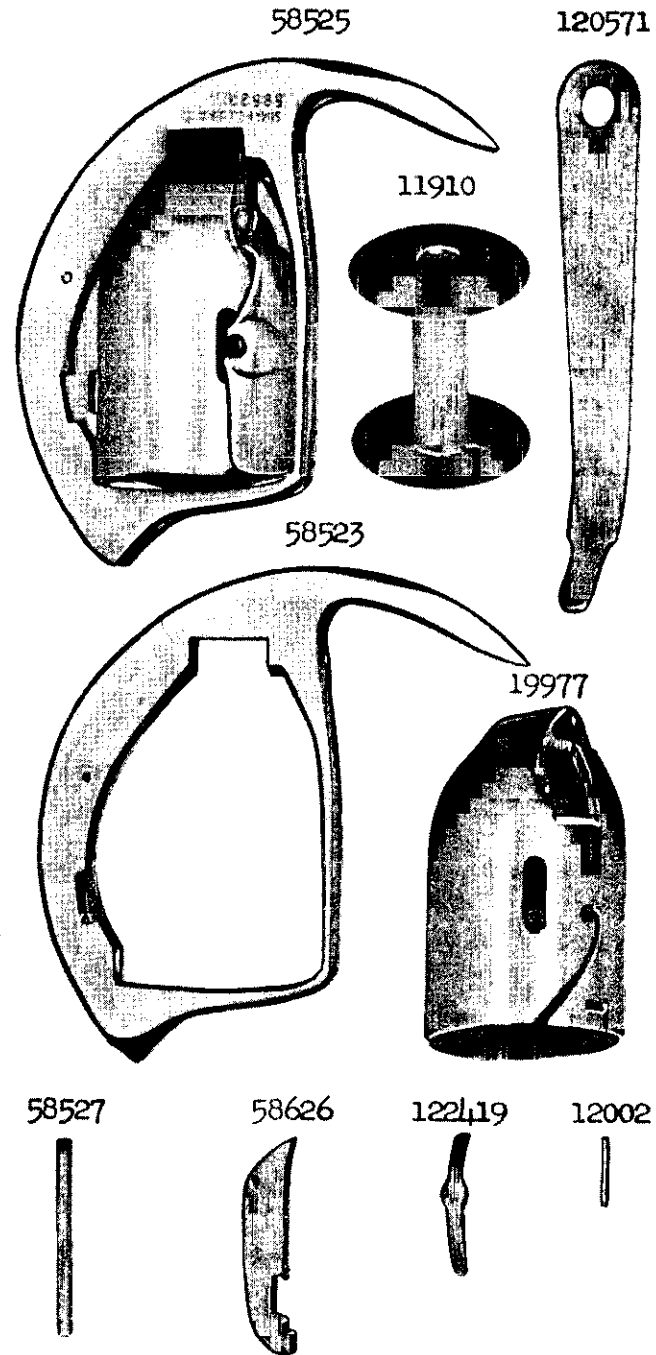


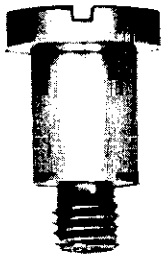
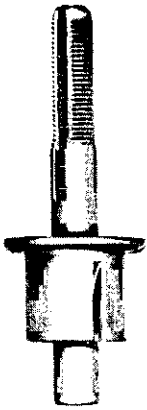
PLATE 9641 - FULL SIZE

607

8873

50437

122



11509

11495

1995

11939



164



434



41544



3905



223



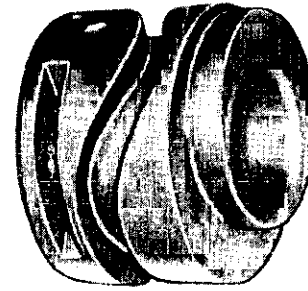
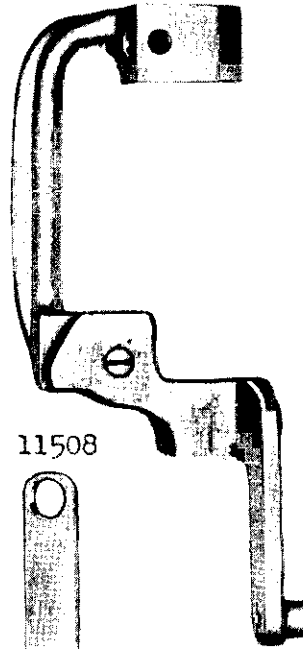
233



PLATE 9642 - ONE-HALF SIZE

58620

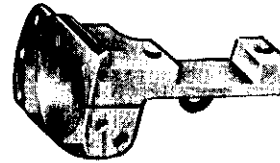
11505



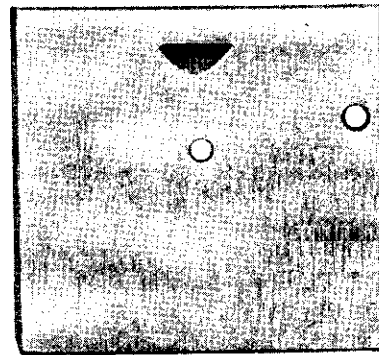
11508



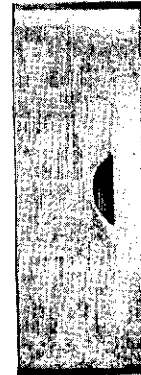
11502



11500



11418



11512

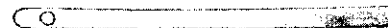


PLATE 9643 - ONE-FOURTH SIZE

11353

11940

11878

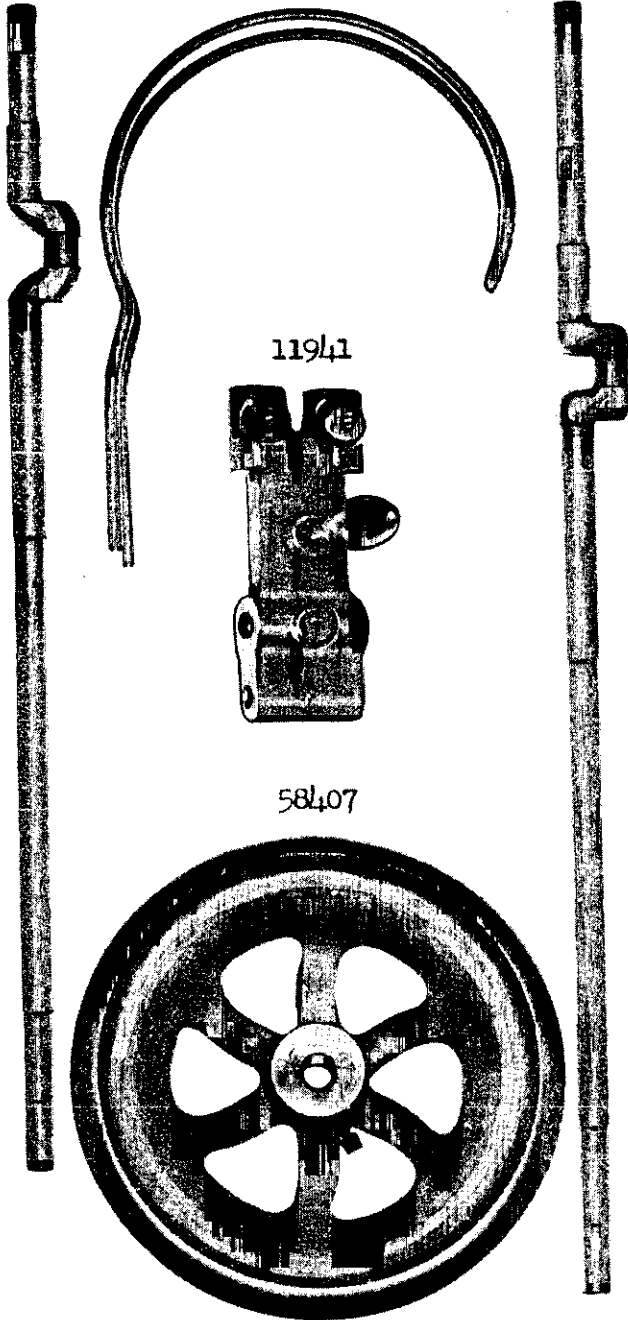
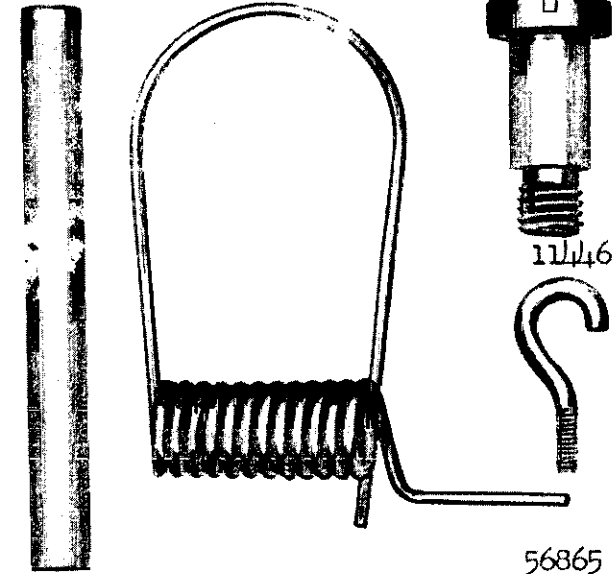


PLATE 9644 - FULL SIZE

4882

4883

567



11446

4879

56864

56865



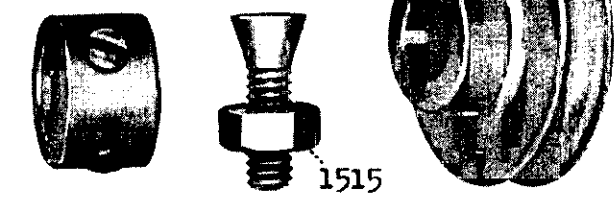
435

448

11447

11453

507



1515

PLATE 9645 - ONE-HALF SIZE

11451



11450



58659



11360



58409



11942

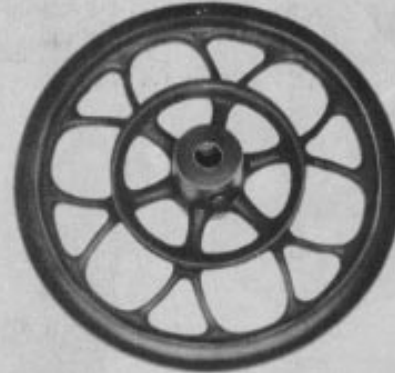


11361

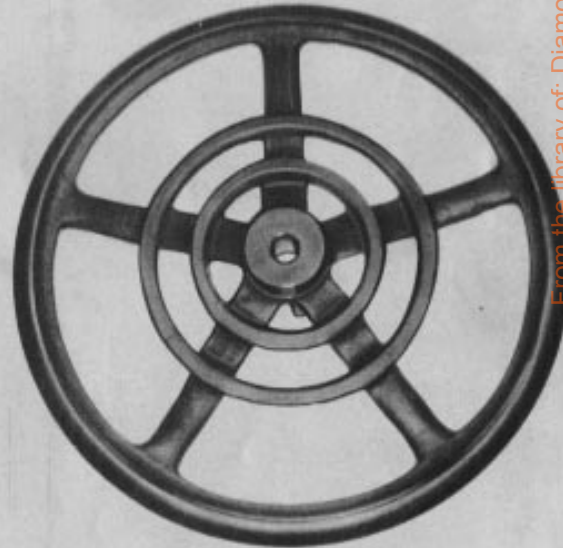


PLATE 9646 - ONE-FOURTH SIZE

58411



11358



From the library of: Diamond Needle Corp

PLATE 9647 - ONE-FOURTH SIZE

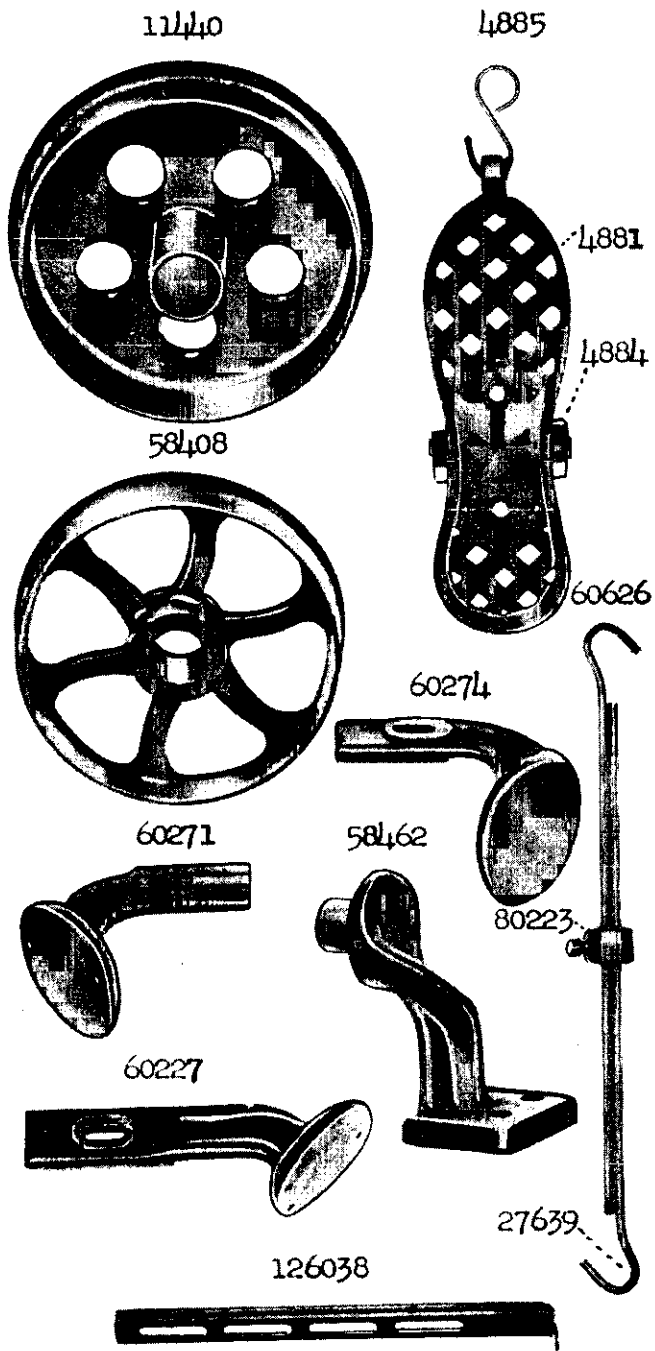


PLATE 9648 - FULL SIZE

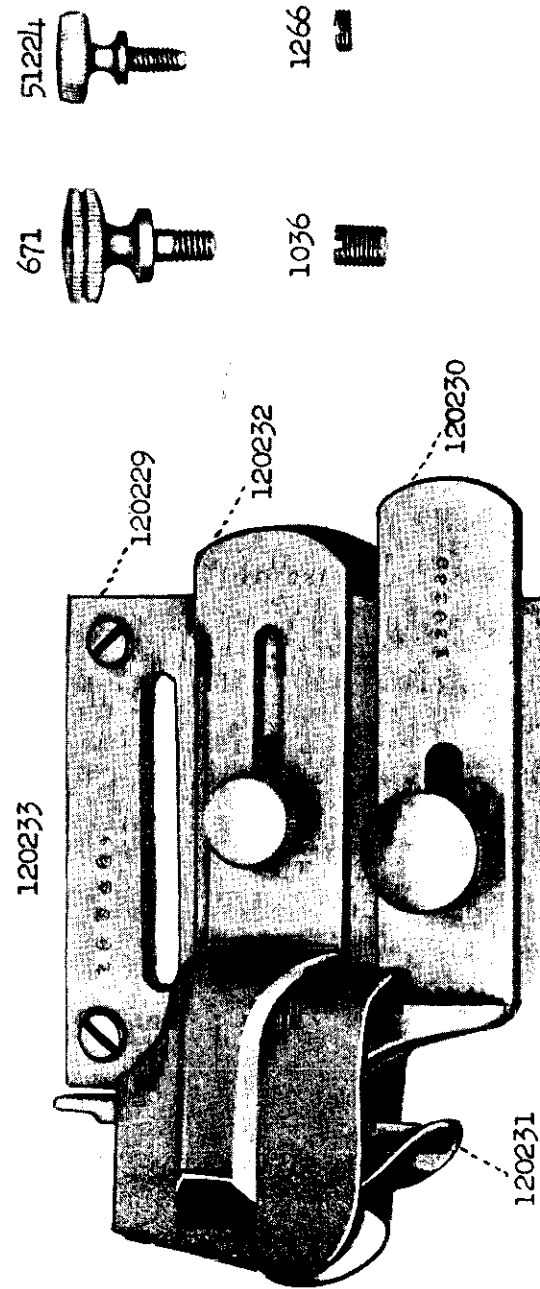


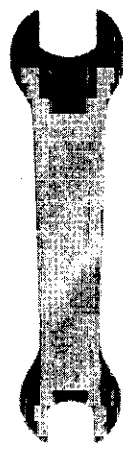
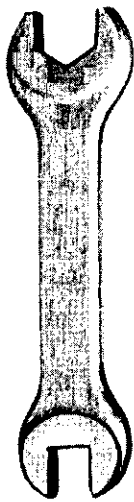
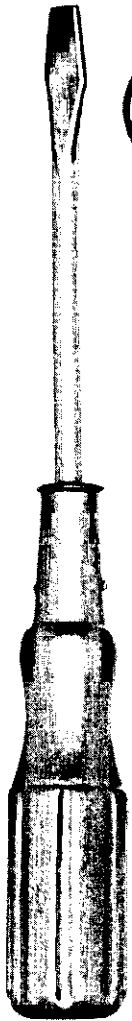
PLATE 9649 - ONE-HALF SIZE

11831

8911

8910

8909

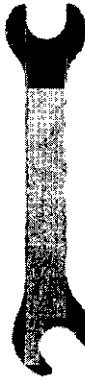
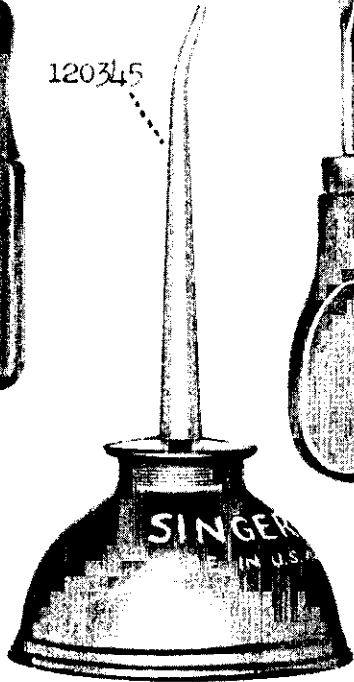


120344

26026

8908

120345



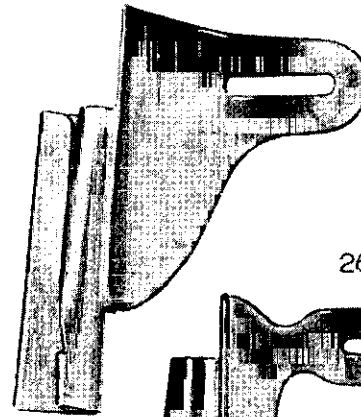
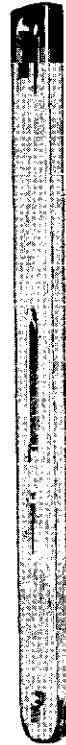
23535



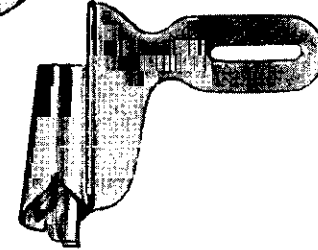
PLATE 9650 - ONE-HALF SIZE

14592

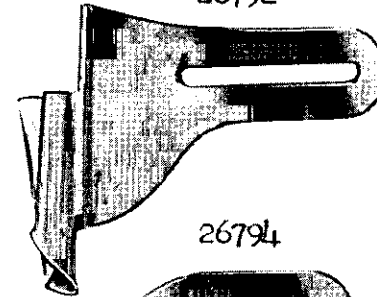
26790



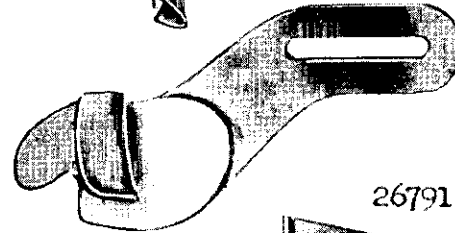
26800



26792



26794



26791

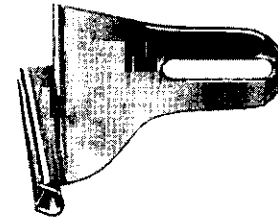
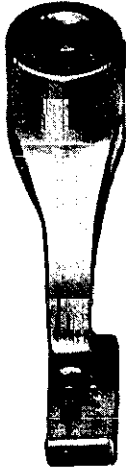


PLATE 22786 - FULL SIZE

19712



19713



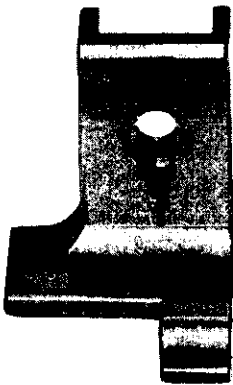
19715



19714



26509



19716



19717

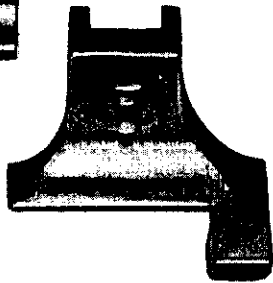
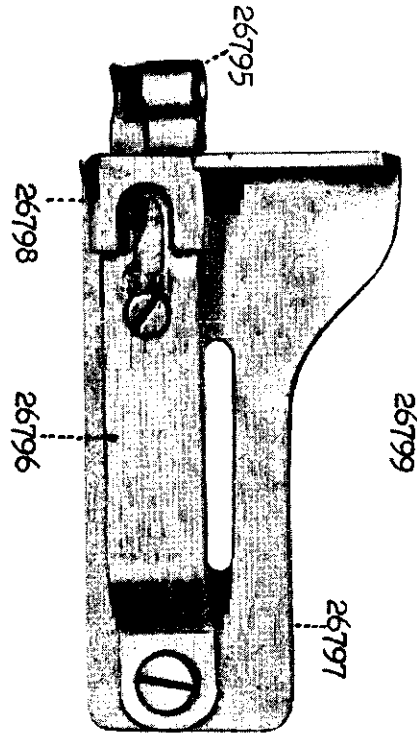


PLATE 22787 - FULL SIZE



190



1044

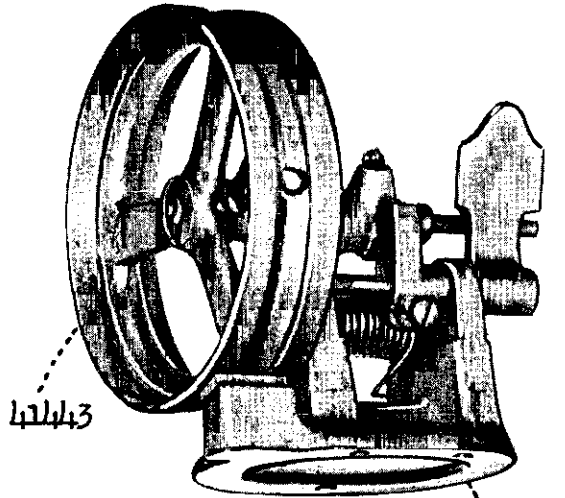


6037

PLATE 22788 - ONE-HALF SIZE

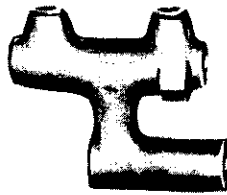
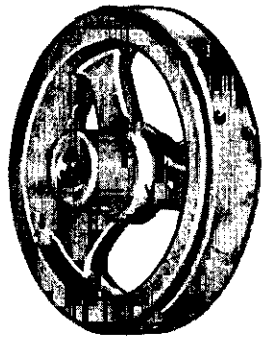
43271

41558



41443

43270



41439

41440

41444



PLATE 22789 - FULL SIZE

41441

50124

41515

28084

4784



41398

41895

458

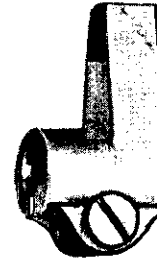
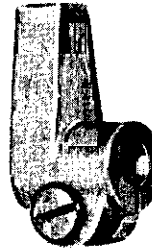


41447

41899

27916

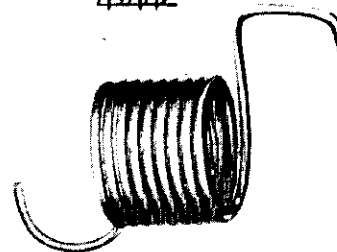
138



41442

894

155



26070

2269

176

330

449



From the library of: Diamond Needle Corp

PLATE 22790 - FULL SIZE

60858

58458

19863

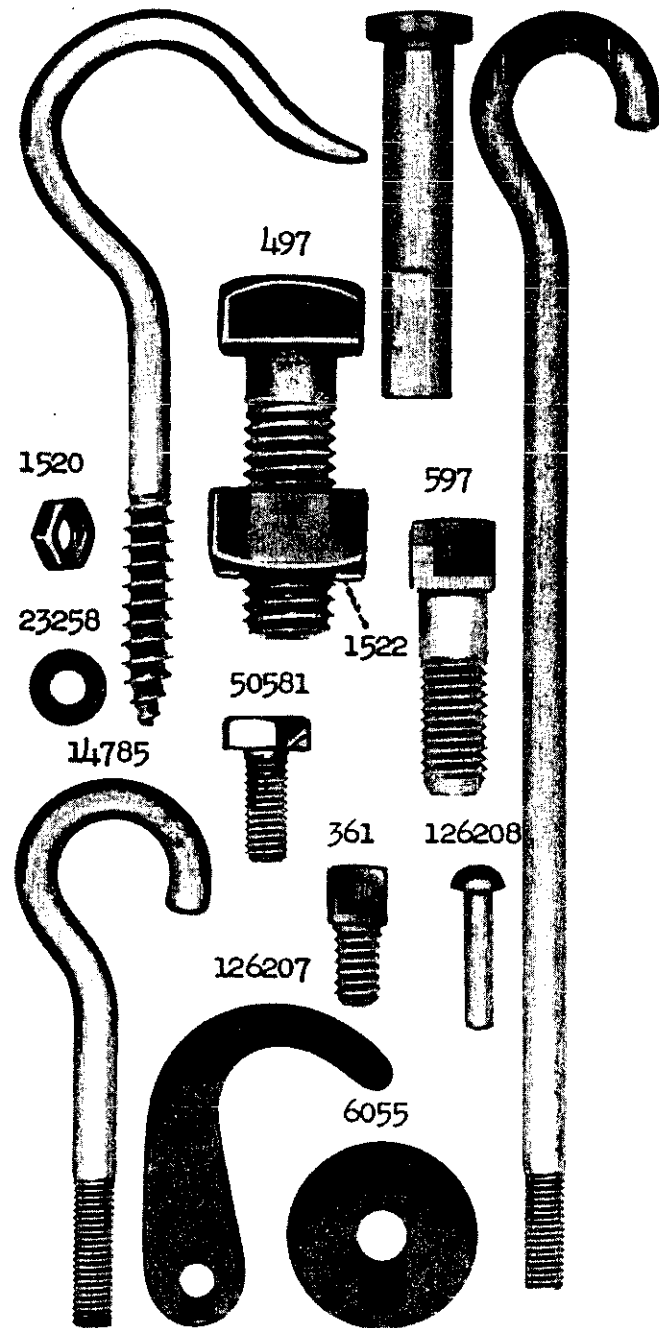


PLATE 22791 - ONE-NINTH SIZE

19662

27693

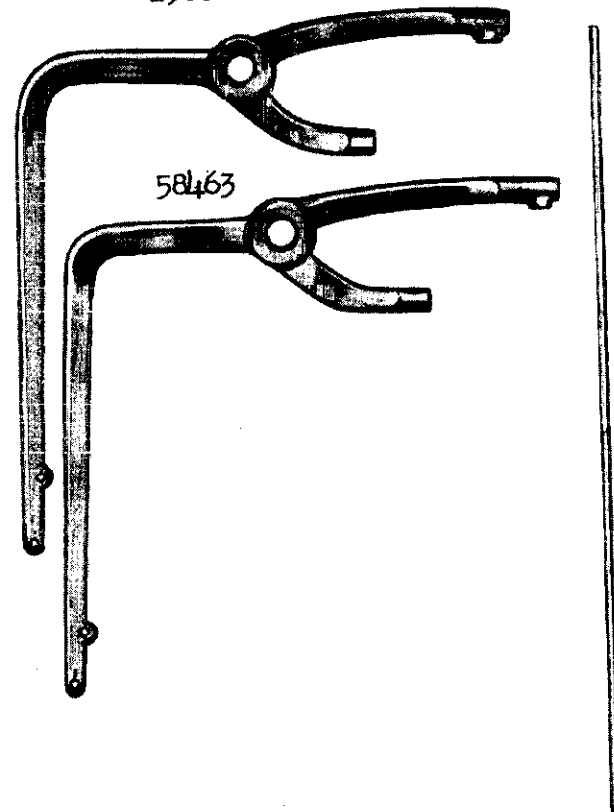
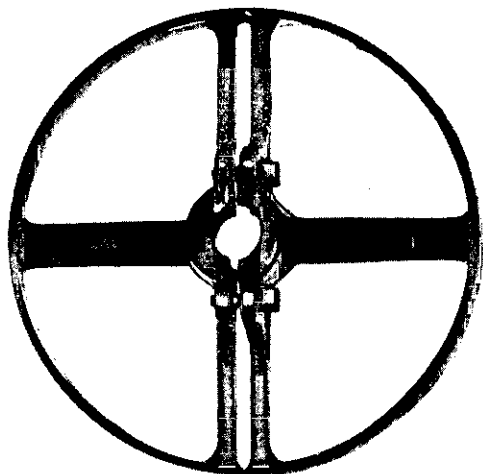
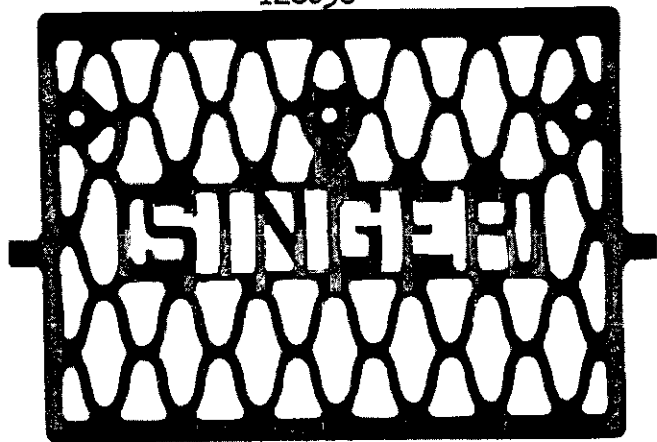


PLATE 22792 - ONE-FOURTH SIZE

9091



126036



60636

19663

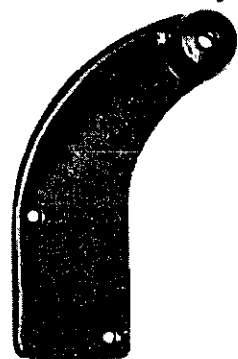
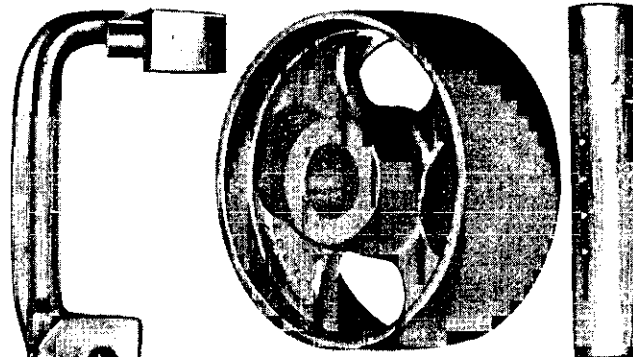


PLATE 22793 - ONE-HALF SIZE

11510

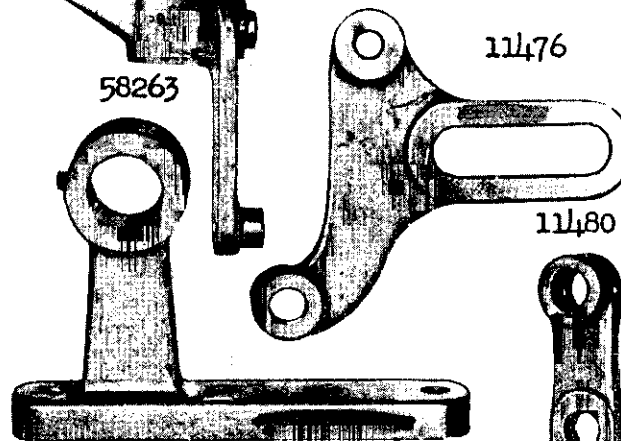
58264

58265



58263

11476

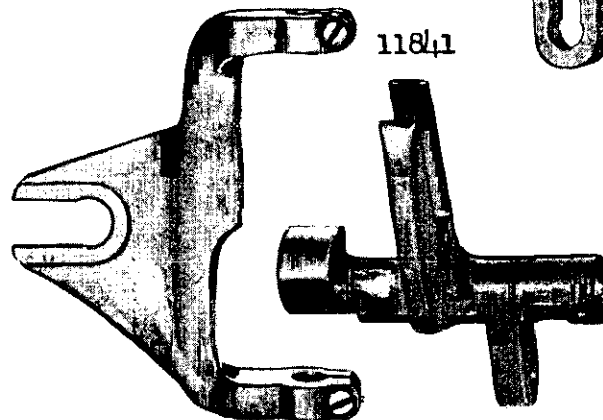


11480

11478



11841

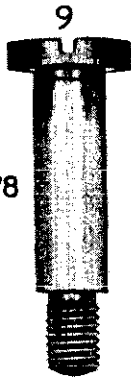
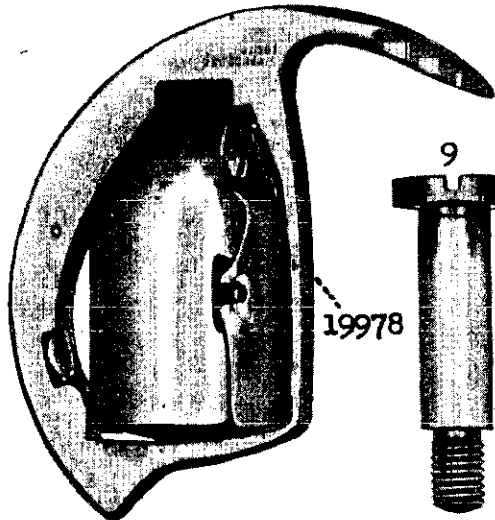
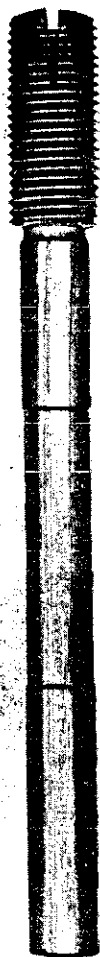


From the library of: Diamond Needle Corp

PLATE 22794 - FULL SIZE

11398

19980



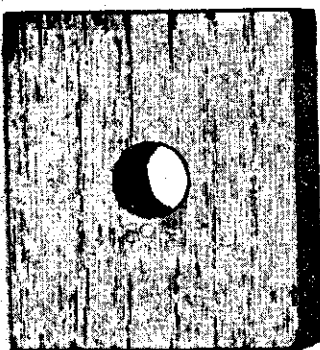
19978

9

8984

150208

362



8961



2762

622

11853

286

19869



58266

